



File-AID for IMS

Reference Summary

Release 10.1

Please direct questions about File-AID for IMS
or comments on this document to:

File-AID for IMS Customer Support

<http://go.compuware.com/>

This document and the product referenced in it are subject to the following legends:

Copyright 1992-2014 Compuware Corporation. All rights reserved. Unpublished rights reserved under the Copyright Laws of the United States.

U.S. GOVERNMENT RIGHTS-Use, duplication, or disclosure by the U.S. Government is subject to restrictions as set forth in Compuware Corporation license agreement and as provided in DFARS 227.7202-1(a) and 227.7202-3(a) (1995), DFARS 252.227-7013(c)(1)(ii) (OCT 1988), FAR 12.212(a) (1995), FAR 52.227-19, or FAR 52.227-14 (ALT III), as applicable. Compuware Corporation.

This product contains confidential information and trade secrets of Compuware Corporation. Use, disclosure, or reproduction is prohibited without the prior express written permission of Compuware Corporation. Access is limited to authorized users. Use of this product is subject to the terms and conditions of the user's License Agreement with Compuware Corporation.

Compuware and File-AID are trademarks or registered trademarks of Compuware Corporation.

CICS, IBM, and IMS are trademarks of International Business Machines Corporation.

Adobe® Reader® is a trademark of Adobe Systems Incorporated in the United States and/or other countries.

All other company and product names are trademarks or registered trademarks of their respective owners.

Contents

Introduction	v
Conventions	1
Summary of Options	1
Default PF Keys	1
Relational Operators	2
Database Update Commands	2
Miscellaneous Commands	4
Line Commands	7
Segment/Layout XREF Commands	8
Selection Criteria Commands	8
Line Commands	9
Scroll Commands	9
Database Movement Commands	10
Edit/Browse Mode Commands	12
Data Disguise Commands (Option 8)	13
Line Commands	13
File-AID for IMS/DC/CICS Commands	14
Edit FLEX Statement Commands (Option F.1)	14

Introduction

This Reference Summary summarizes the commands for File-AID for IMS/ISPF, File-AID for IMS/DC/CICS. The commands for each product are listed separately in alphabetic order. For more information, refer to the *File-AID for IMS/ISPF Reference* manual, the *File-AID for IMS/DC/CICS Reference* manual, and the *File-AID for IMS/FLEX Reference* manual.

Note: An asterisk (*) indicates the command applies to File-AID for IMS/ISPF only.

Notation Rules

This manual uses the following notation rules:

- Screen, field, and column names appear with initial caps. For example:
 - ...on the Extract Specification screen
 - ...in the Region Type field
 - ...in the Line Cmd column
- Primary command names appear in all uppercase. For example: Enter the FIELD command to...

Reading the Syntax Diagrams

Syntax diagrams define primary command syntax.

A **parameter** is either a keyword or a variable.

- All KEYWORDS are shown in uppercase characters and must be spelled exactly as shown. You cannot substitute another value. If any part of a KEYWORD is shown in lowercase characters, that part is optional.
- Variables are user-specified values and are printed in lowercase italics. For example, *dataset-name* indicates you are to substitute a value.

The syntax for commands is described in diagrams that help you visualize parameter use. The following example shows a command and a parameter:

▶▶—COMMAND—parameter—◀◀

Read the diagrams from left to right and from top to bottom. These symbols help you follow the path of the syntax:

▶▶ indicates the beginning of a statement.

- ➔ indicates the statement is continued on the next line.
- ▶ indicates the statement is continued from the previous line.
- ➞ indicates the end of a statement.

Required parameters appear on the horizontal line (the main path). Optional parameters appear below the main path. Default parameters appear above the main path and are optional. The command will execute the same whether the default parameter is included or not.

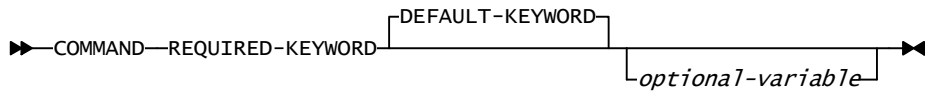

Vertically stacked parameters are mutually exclusive. If you must choose a parameter, one item of the stack appears on the main path. If the parameters are optional, the entire stack appears below the main path. If a parameter in a stack is the default, it appears above the main path.

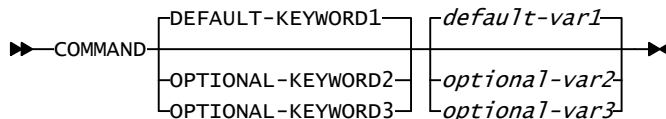

If the same parameters are used with several commands, their syntax may be documented in a separate diagram. In the command syntax, these common parameters are indicated with separators before and after the parameter name.



An arrow returning to the left indicates a repeatable item. If the arrow contains a comma, separate the repeated items with a comma.

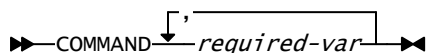

Conventions

Summary of Options

- 0 File-AID for IMS/ISPF Parameters
- 1 Browse Database
- 2 Edit Database
- 3 Utilities
- 4 Extract/Load Database
- 5 Print
- 6 Selection Criteria
- 7 Segment/Layout XREF
- 8 Data Privacy
- 9 Application Relationship
- F FLEX
- C Summary of Changes
- T Tutorial

Default PF Keys

	File-AID for IMS/ISPF	File-AID for IMS/DC/CICS
PF1/13	HELP	MENU
PF2/14	SPLIT	DBD
PF3/15	END	END
PF4/16	NEXT	NEXT
PF5/17	RFIND	CHILD
PF6/18	RCHANGE	TWIN
PF7/19	UP	UP
PF8/20	DOWN	DOWN
PF9/21	SWAP	PARENT
PF10/22	PARENT	LEFT
PF11/23	ROOT	RIGHT
PF12/24	RETURN	ROOT

Relational Operators

EQ or =	Equal to
NE or \neq	Not equal to
GT or >	Greater than
LT or <	Less than
GE or \geq	Greater than or equal to
LE or \leq	Less than or equal to
BT	Within a range of two values (endpoints inclusive)
NB	Outside a range of two values (endpoints exclusive)
CO	Contains a string
NC	Does not contain a string

Database Update Commands

CAN, CANCEL : Restores the screen to reflect the segment contents in the database. All typeovers not yet posted to the database are ignored. This command is especially useful if a DA or RX status code is returned because a key field was inadvertently typed over.

***CHANGE** : Finds and changes one or more occurrences of string-1 to string-2.

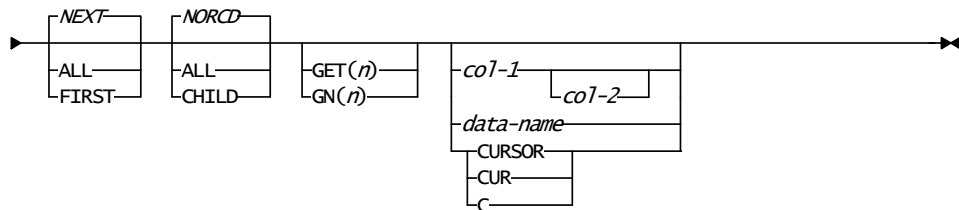
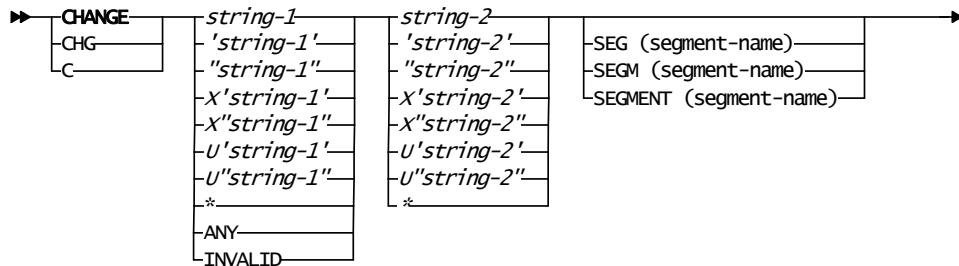

D, DEL, DELETE : Deletes the current segment and all its dependents.

***FIND** : Searches the database for one or more occurrences of the specified string in the database (also valid in browse).

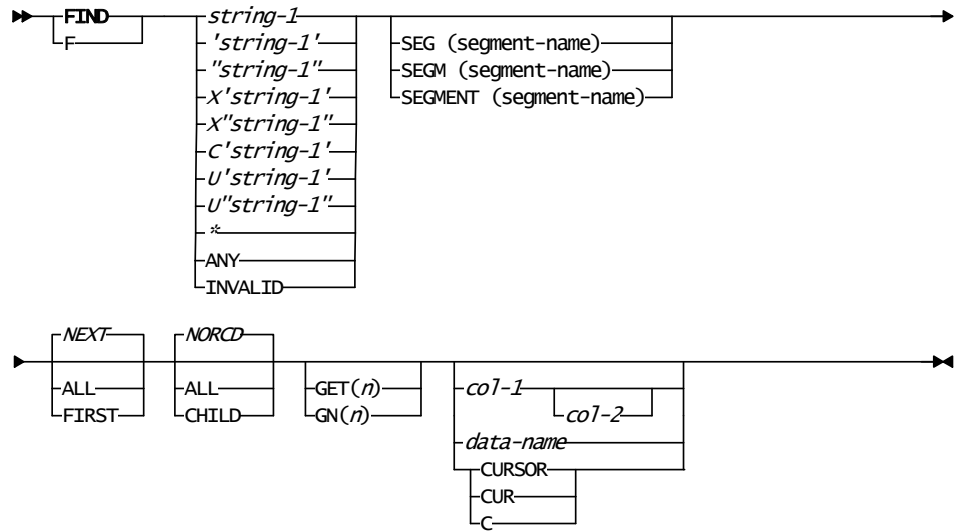

INSERT : Inserts an initialized segment of either the current segment type or segname segment type. If the segment has multiple record types, record type values default to the current segment's values if they are not specified.

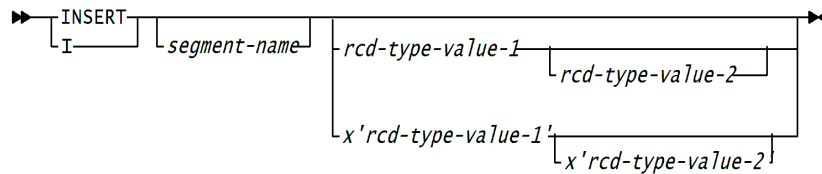

***RCHANGE** : Repeats the previous CHANGE command.

REPEAT : Redisplay the current segment. If ALL is specified, repeats all dependent segments under the current segment.

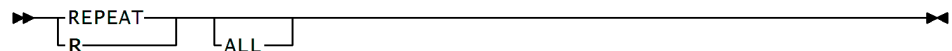

***RFIND** : Repeats the previous FIND command.

Miscellaneous Commands

***ADM** : Displays the Administration main menu if access to this function from the product panels has been enabled.

BMP : Displays the “File-AID for IMS – Modify BMP Parameters” screen, where you can override certain BMP parameters.

CAPS : Controls whether alphabetic data entered is translated to uppercase or left as is.

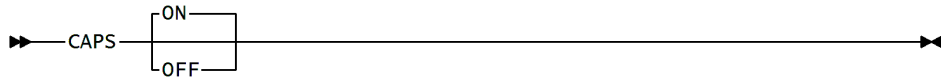

***COB, COBOL** : Changes language mode to COBOL.

***CURSOR** : Moves the cursor to the first input field on line 2 of the screen.

***DB, DBCS** : Changes display format to DBCS.

DLI : Displays the “File-AID for IMS – Modify DLI Parameters” screen, where you can override certain DLI parameters.

***DSN** : Displays all dataset concatenations defined to the session.

***EB, EBCDIC** : Changes display format to EBCDIC.

END : Terminates the current function, and returns control to the next higher level screen.

***ENV** : Displays the Select IMS Environment screen, where you can select/view system parameters and concatenations associated with a specific environment. Can generate a printed report of environment configurations.

EXCLUDE : Unprotects/protects the left side of the Formatted screen so that X line commands can be entered.

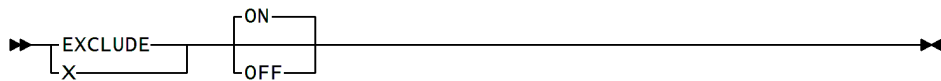

***FPRINT** : Displays the Formatted Print screen to allow print selection of one or more segments based on a layout of each segment.

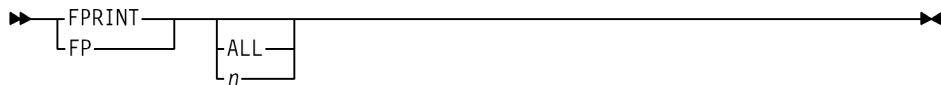

***HELP** : Displays the extended description of a message or invokes the online tutorial.

HEX : Displays the data in hexadecimal or character format.

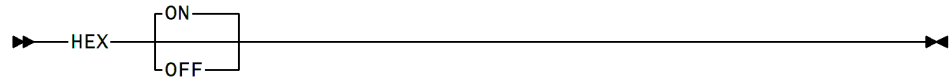

***HI, HIER, HIERARCHY** : Displays the hierarchical structure of the database being browsed or edited graphically.

***IMS** : Displays the IMS Parameters screen, where you can override the certain IMS parameters defined to an environment.

***INFO** : Displays the DBD/Segment Information screen when this command is entered from the Segment Information screen.

***JCL** : Creates JCL and invokes ISPF Edit.

***KEYS** : Displays the current PF key definitions.

***MARK** : Creates or lists names for database locations.

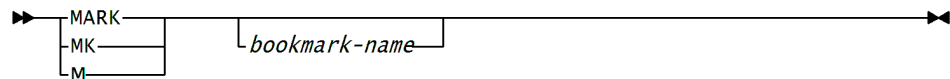

***MIX, MIXED** : Changes display format to mixed DBCS and EBCDIC.

***PANELID** : Displays screens with or without the panel identifier in the upper left corner of the screen.

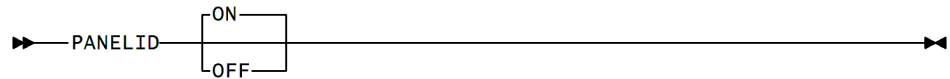

***PFSHOW** : Displays the current PF key definitions at the bottom of the screen.

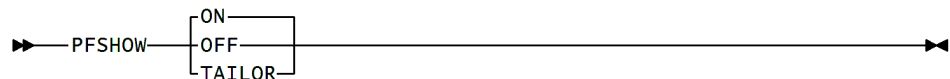

***PLI, PL1, PL/I, PL/1** : Changes language mode to PL/I.

***PRINT** : Generates a snapshot of the current screen to be recorded in the ISPF list file.

***PRINT-HI** : Same as PRINT except prints high-intensity characters with overstrikes to simulate high-intensity display.

***PRINTL** : Generates a snapshot of the current logical screen to be recorded in the ISPF list file.

***PRINTL-HI** : Same as PRINTL except prints high-intensity characters with overstrikes to simulate high-intensity display.

***PRT** : Displays the “System Parameters Screen”, which controls printing of File-AID for IMS reports.

***RECOVERY** : Initially set to OFF; n defaults to 1. If ON, takes a checkpoint after every n database update.

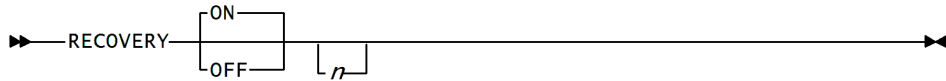

REF, REFRESH : Retrieves the current version of the segment from the edit formatted or unformatted mode. Retrieves the current version of the first displayed segment containing typeovers from the edit index mode. Available under File-AID for IMS/ISPF only with BMP region type.

RES, RESET : Resets intensified messages, incomplete line commands, and previously excluded lines.

***RESTORE** : The RESTORE command restores the default environment settings on the File-AID for IMS Option 0 panels, which are the IMS Parameters options screens.

***RETRIEVE** : Recalls previously entered commands to the command line.

RETURN : Returns to the Primary Option Menu or the specified option.

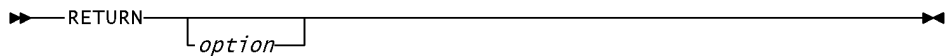

***SAVE** : Issues a checkpoint. IMS forces all database buffers to be written.

SELECT : Selects a member from a member list screen.

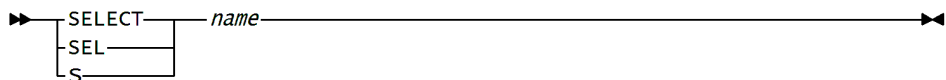

***SPLIT** : Enters split screen mode or changes the location of the split line.

***SWAP** : Positions the cursor to wherever it was previously located on the other logical screen.

***SYS** : Displays the System Parameters screen, which controls the language mode, data format, PSB processing, CAPS mode, and CODEPAGE options.

TMP : Displays the “Temporary Dataset Allocations Screen”, where you can control the allocation of the IMS log and File-AID for IMS audit trail.

***TSO** : Allows a TSO command or CLIST to be entered from the COMMAND or OPTION field of any screen.

***VHEX** : Displays the “Edit Unicode Field” screen for the selected Unicode field. There you can edit the field in hexadecimal image. Each character is identified by its Unicode hex value and its description. Place the cursor on the target field value before you press ENTER.

- ***VIEW** : Displays all system configuration settings and dataset concatenations in effect for the current session. Can generate a printed report for the current session.
- ***ZOOM** : Enables you to view entire concatenated key and record type values and edit field values within a segment occurrence based on a specified layout.
- ***ZOOMH** : Enables you to view entire concatenated key and record type values and edit field values in a scrollable panel in three-line vertical hexadecimal format.

Line Commands

- *C** Copies an existing environment to a new environment on the Administration option Select Environment screen.
- D** Deletes a segment and all its dependents.
 - * Deletes an environment definition on the Administration option Select Environment screen.
 - * Deletes a dataset entry in a concatenation list defined for an environment on the Administration option Dataset Concatenation screen.
 - * Deletes a bookmark defined on the Bookmark screen.
- H** Graphically displays the structure (Hierarchy) of the the selected DBD during extract and load.
- I** Inserts a new segment.
 - * Inserts a dataset entry in a concatenation list defined for an environment on the Administration option Dataset Concatenation screen.
- K** Invokes the Key Specification screen, then switches to the formatted display (from the Character/Index screen, invokes the Key Specification screen).
 - * Invokes the Key Specification screen from the Bookmark screen. Upon successful execution of the Key Specification screen displays the segment in Formatted mode.
- *KC** Invokes the Key Specification screen, then switches to the character display.
 - * Invokes the Key Specification screen from the Bookmark screen. Upon successful execution of the Key Specification screen displays the segment in Character mode.
- KI** Invokes the Key Specification screen, then switches to the character display.
 - * Invokes the Key Specification screen from the Bookmark screen. Upon successful execution of the Key Specification screen displays the segment in Character mode.
- KU** Invokes the Key Specification screen, then switches to the unformatted display.
 - * Invokes the Key Specification screen from the Bookmark screen. Upon successful execution of the Key Specification screen displays the segment in Unformatted mode.
- R** Repeats a segment.
 - * Renames an environment on the Administration option Select Environment screen.
 - * Repeats a line on the Administration option Dataset Concatenation screen.
 - * Renames a bookmark defined on the Bookmark screen.
- RA** Repeats a segment and all its dependents.

- S** Selects a segment for formatted display.
 - * Selects an environment on the Select IMS Environment screen for processing.
 - * Selects an environment on the Administration option Select Environment screen for updating.
 - * Selects a migrated dataset for recall or displays error message text on the View Dataset Concatenations screen or the Administration option Dataset Concatenation screen.
 - * Selects a bookmark on the Bookmark screen and displays segment associated with the selected bookmark in Formatted mode.
- *SC** Selects a segment for character display.
 - * Selects a bookmark on the Bookmark screen and displays segment associated with the selected bookmark in Character mode.
- SI** Selects a segment for character display.
 - * Selects a bookmark on the Bookmark screen and displays segment associated with the selected bookmark in Character mode.
- SU** Selects a segment for unformatted display.
 - * Selects a bookmark on the Bookmark screen and displays segment associated with the selected bookmark in Unformatted mode.
- *V** Displays a Browse panel for viewing the values of current configuration settings and system datasets defined within a selected environment on the Select IMS Environment screen.
- X** Excludes a line.
- Xn** Excludes *n* lines.
- XX** Excludes a block of lines.

Segment/Layout XREF Commands

DELETE : Deletes a DBD from the XREF.

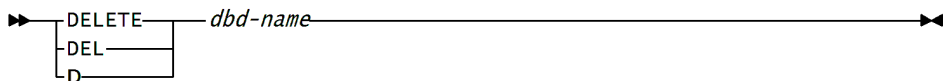

INSERT : Adds a new DBD to the XREF.

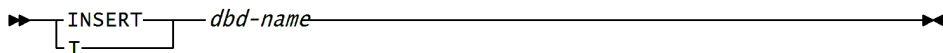

Selection Criteria Commands

CAN, CANCEL : Returns control to the Selection Criteria Dataset Specification screen. Does not apply any updates to the selection criteria member since the selection criteria function was entered or since the last SAVE command.

FIELD, FLD : View and/or specify field criteria.

REL, RELATION, RELATIONSHIP : View and/or specify database relationship criteria.

SAVE : Applies all updates to the selection criteria member made since the selection criteria function was entered or since the last **SAVE**.

SAVEAS : When editing selection criteria, including temporary selection criteria, **SAVEAS**, or **SAVAS**, store the selection criteria data in a different dataset or member.

SEG, SEGMENT : View and/or specify segment criteria.

Line Commands

D Deletes a field criteria set or a field criterion.

Dn Deletes *n* field criteria sets or *n* field criterion.

I Inserts a field criteria set or a field criterion.

In Inserts *n* field criteria sets or *n* field criterion.

R Repeats a field criteria set or a field criterion.

Rn Repeats *n* field criteria sets or *n* field criterion.

S Selects a field criteria set, a field criterion, or a segment criterion for further processing.

Scroll Commands

LOCATE : Scrolls up/down to the specified line-number, data-name, member-name, and bookmark-name.

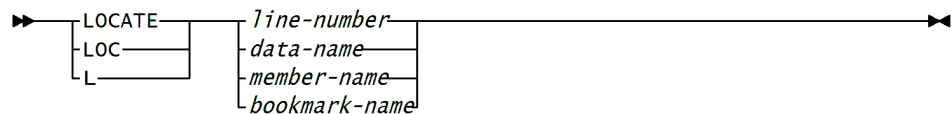

RIGHT/LEFT : Scrolls toward the right/left margin of the data. On the Member List screen, these commands toggle between alternate displays of the screen.

The fields vary depending upon the type of library for which the member list is being displayed.

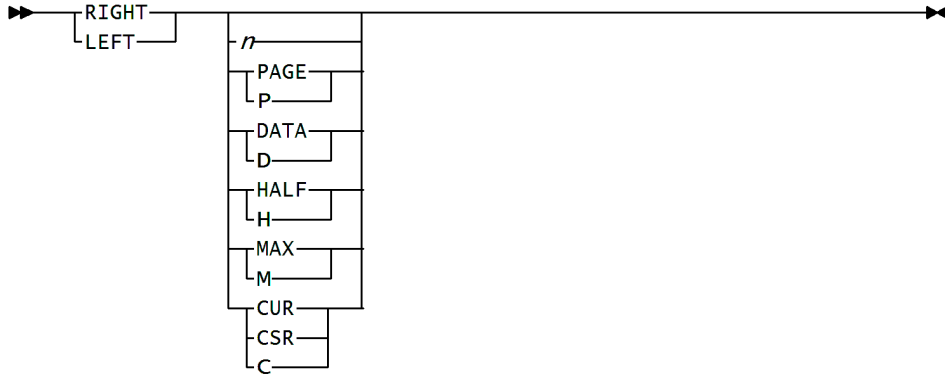

UP/DOWN : Scrolls toward the top/bottom of a segment, database, segment layout, member list, and bookmarks list.

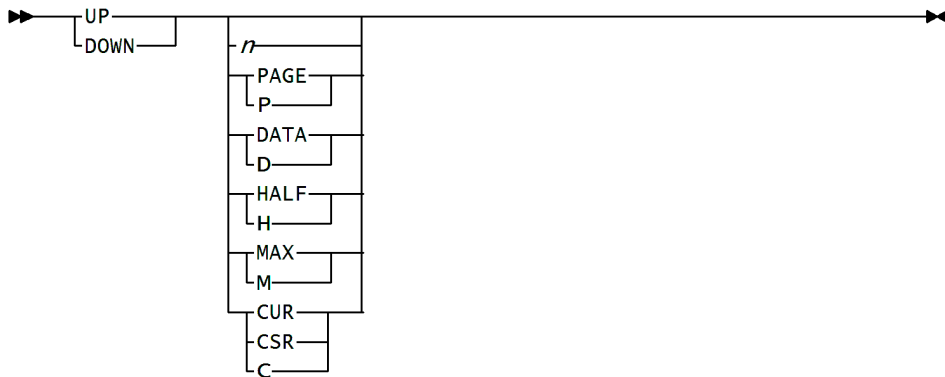

Database Movement Commands

CHILD : Retrieves a child under the current segment type. If segname is not specified, the segment type of the first child defined in the DBD is assumed.

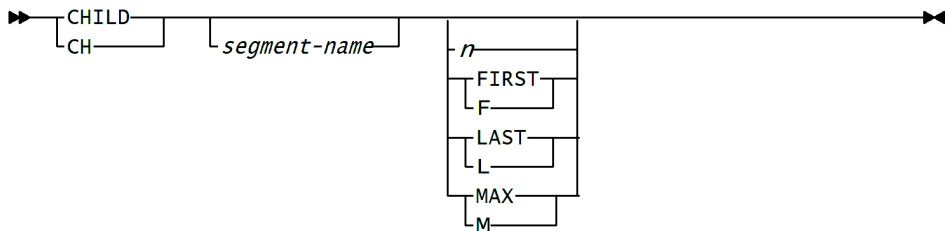

END : Returns to the Edit Data Base Location screen to allow selection of a new segment from the Formatted, Unformatted, and Character modes.

***GOB** : Scrolls back through displayed segments.

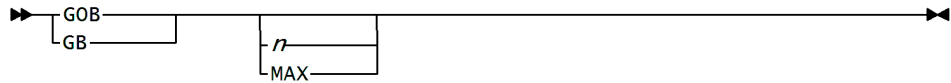

***GOF** : Scrolls forward through displayed segments.

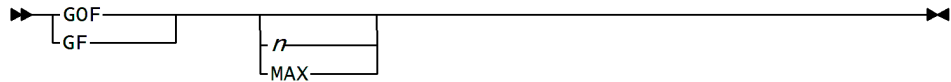

***GOH/GOT** : Retrieves first segment displayed in the Formatted, Unformatted, and Character modes.



***GOL** : Retrieves most recent segment displayed.

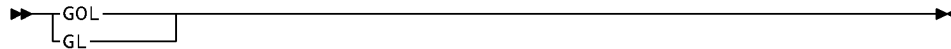

***GOM** : Navigates to a database bookmark location.

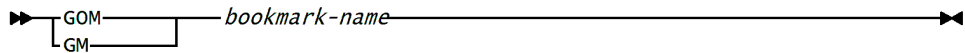

KEY : Displays the Key Specification screen to allow specification of a new fully concatenated key. The target segment type to be retrieved is the specified segname operand. If segname is not specified, the target is assumed to be the current segment type. The concatenated key for the target segment type is displayed and a new occurrence of the target is retrieved.

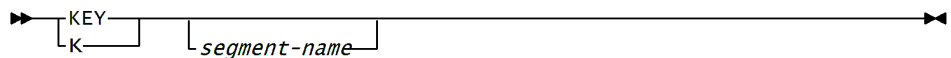

NEXT : Moves forward in the database *n* segments without regard to parentage.
If a segname is specified, retrieves only occurrences of that segment type.

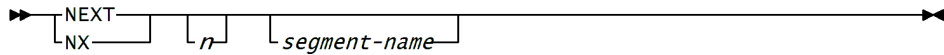

PARENT : Moves to a parent of the current segment. If segname is not specified, retrieves the immediate parent; otherwise, retrieves the specified parent.

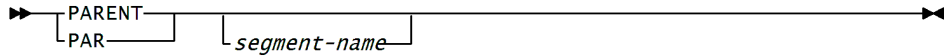

ROOT : Moves back to the highest level parent (root) of the current segment. If FIRST is specified, retrieves the first root in the database.

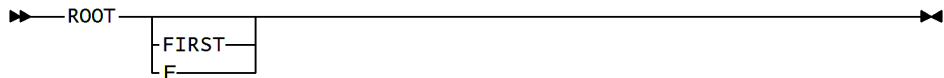

TWIN : Selects another segment of the current type under the current parent.
Stops with POSN BEYOND TWINS message if desired segment not found. If another TWIN [*n*] is issued, retrieves the next occurrence of the segment type under new parents.



Edit/Browse Mode Commands

***CHAR** : Switches from formatted or unformatted to character mode.

FMT, FORMAT : Switches from character/index or unformatted to formatted mode.

INDEX : Switches from formatted or unformatted to index mode.

UNFMT, UNFORMAT : Switches from formatted or character/index to unformatted mode.

***XPSB** : Switches to and from dynamic and static variations of the File-AID for IMS screens regarding PSB processing if your installation has enabled both dynamic and static PSB processing.

Data Disguise Commands (Option 8)

ALL : Allows you to step through all menu options in sequence. Profile, Extract, and Load menus only. Selects all objects in the Object List Preview windows.

FIND : Searches the displayed data and positions the line with the first occurrence of the find-string to the first line of the displayed data. Valid whenever a list is displayed.

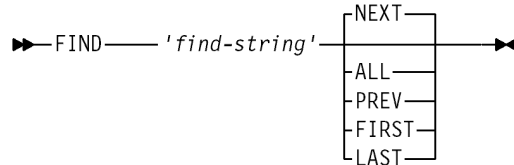

OBJECTIN (OI) : Allows you to add objects to your current object list. This command displays the ObjectIn - IMS Object Filter screen. The ObjectIn Filter panels work the same as the NEW - IMS Object Filter screens.

OBJECTOUT (OO) : Allows you to remove objects from your current object list. This command displays the ObjectOut - IMS Object Filter screen.

SIZE (SI) : Toggles the size of list display area by hiding or displaying the panel header lines in various list display screens.

Line Commands

A Displays the Associated Rules List where you can select an already defined associated disguise rule or create a new associated rule to assign to a selected column.

I I line command summary:

- Display information about a relationship
- Display detailed information about an extract, delete, or load request
- Display DDL for selected IMS object
- Display data disguise information for an object
- Display data disguise information for a column/field

O In the Data Disguise - Object List, removes the selected object from the object list.

R In the Data Disguise - Object List, searches the relationship file and displays any related objects that are not yet included in the object list. Then you can select any of the related objects to be added to the object list.

S Selects:

- Object for data disguise
- Column/field for data disguise

U Removes a disguise rule from a column in the "Data Disguise - Column List".

File-AID for IMS/DC/CICS Commands

DBD Returns to the DBD Member List screen.

MENU Returns to the Primary Option Menu.

Edit FLEX Statement Commands (Option F.1)

MODEL : Selects a FLEX model to be included in a member of a FLEX command statement dataset.

VALIDATE : Validates the syntax of FLEX statements contained in a member of a FLEX command statement dataset.