



The Mainframe Software Partner
For The Next 50 Years

File-AID *for DB2*

Reference Summary

Release 16.03

Please direct questions about *File-AID for DB2*
or comments on this document to:

Compuware Customer Support

<http://go.compuware.com/>

This document and the product referenced in it are subject to the following legends:

Copyright 1989-2015 Compuware Corporation. All rights reserved. Unpublished rights reserved under the Copyright Laws of the United States.

U.S. GOVERNMENT RIGHTS-Use, duplication, or disclosure by the U.S. Government is subject to restrictions as set forth in Compuware Corporation license agreement and as provided in DFARS 227.7202-1(a) and 227.7202-3(a) (1995), DFARS 252.227-7013(c)(1)(ii) (OCT 1988), FAR 12.212(a) (1995), FAR 52.227-19, or FAR 52.227-14 (ALT III), as applicable. Compuware Corporation.

This product contains confidential information and trade secrets of Compuware Corporation. Use, disclosure, or reproduction is prohibited without the prior express written permission of Compuware Corporation. Access is limited to authorized users. Use of this product is subject to the terms and conditions of the user's License Agreement with Compuware Corporation.

DBA-XPert, File-AID, File-AID/Related Data XPert, Xpediter, and Compuware are trademarks or registered trademarks of Compuware Corporation.

Adobe® Reader® is a trademark of Adobe Systems Incorporated in the United States and/or other countries.

IBM and DATABASE 2 (DB2) are trademarks of International Business Machines Corporation.

All other company and product names are trademarks or registered trademarks of their respective owners.

Contents

File-AID for DB2 Reference Summary	1
File-AID for DB2 Menu Facilities	1
Notation Rules	2
Reading the Syntax Diagrams	2
Primary Commands	4
Line Commands	16
User Profile Defaults	17
Object Administration	18
Notation Rules	18
Reading the Syntax Diagrams	18
Conventions	19
Creating a Fast-Path Command	24
Primary Commands	24
Row Commands	35
Edit	41
Guidelines for the Work Buffers	42
Retrieving Work Buffer Contents	43

File-AID for DB2 Reference Summary

This *Reference Summary* lists the menu facilities, PF Key designations, and primary and line commands for File-AID for DB2. For more information, refer to the *File-AID for DB2 Reference* manual. The *Quick Reference* also explains the conventions and facilities for Object Administration, a File-AID for DB2 utility. It also lists Object Administration primary and row commands. For more information, refer to the *File-AID for DB2 Object Administration User Reference* manual.

File-AID for DB2 manuals are available on the Compuware Go customer support website at <http://go.compuware.com> and the File-AID for DB2 distribution media.

File-AID for DB2 Menu Facilities

The File-AID for DB2 Primary Option Menu provides access to the following facilities:

- 0 Defaults and User Params
- 1 Browse
- 2 Edit
- 3 Utilities
 - 3.1 Object Administration
 - 3.2 Create, Model, Drop, Alter DB2 Objects
 - 3.3 Copy Rows Between Tables
 - 3.4 Object List Processing
 - 3.5 SQL Command Manager
 - 3.6 Display, Grant, or Revoke DB2 Privileges
 - 3.7 Extract and Load Tables
 - 3.8 DBA-XPert Column Impact Analysis
 - 3.9 Batch Execute SQL with Auto-COMMIT Processing
- 4 SQL Development and Analysis
- 5 Print Table Data or Audit Trail
- 6 Relationship Facilitator
- 7 Data Disguise
- R Transfer to File-AID/Related Data XPert (RDX)
- XT Transfer to Xpediter
- T Display Information about File-AID for DB2
- L Copyright and Trade Secret Notice
- C Display Summary of File-AID for DB2 changes
- X Exit File-AID for DB2

Notation Rules

The following notation rules are used throughout this document:

- Minimum strings for commands and keywords are shown in UPPERCASE characters and must be spelled exactly as shown.
- All variables are user-specified values; they are printed in *lowercase italics*. For example, *dataset-name* indicates that you are to substitute a value.

Reading the Syntax Diagrams

Syntax diagrams define primary command syntax.

- A **parameter** is either a keyword or a variable.
 - All KEYWORDS are shown in uppercase characters and must be spelled exactly as shown. You cannot substitute another value. If any part of a KEYWORD is shown in lowercase characters, that part is optional.
 - Variables are user-specified values and are printed in lowercase italics. For example, *dataset-name* indicates you are to substitute a value.

The syntax for commands is described in diagrams that help you visualize parameter use. The following example shows a command and a parameter:

▶▶—COMMAND—parameter—◀◀

Read the diagrams from left to right and from top to bottom. These symbols help you follow the path of the syntax:

- ▶▶ indicates the beginning of a statement.
- indicates the statement is continued on the next line.
- ▶ indicates the statement is continued from the previous line.
- ◀◀ indicates the end of a statement.

Required parameters appear on the horizontal line (the main path). Optional parameters appear below the main path. Default parameters appear above the main path and are optional. The command executes the same whether the default parameter is included or not.

▶▶—COMMAND—REQUIRED-KEYWORD—DEFAULT-KEYWORD—*optional-variable*—◀◀

Vertically stacked parameters are mutually exclusive. If you must choose a parameter, one item of the stack appears on the main path. If the parameters are optional, the entire stack appears below the main path. If a parameter in a stack is the default, it appears above the main path.

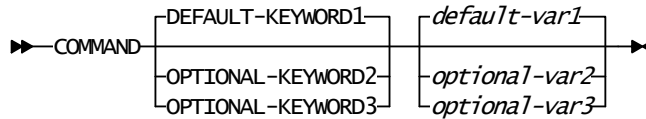

If the same parameters are used with several commands their syntax may be documented in a separate diagram. In the command syntax, these common parameters are indicated with separators before and after the parameter name.



An arrow returning to the left indicates a repeatable item. If the arrow contains a comma, separate the repeated items with a comma.

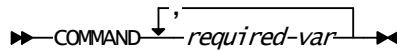

Partial Column Names

If a primary command allows a parameter of *column-name*, you can specify a partial column name instead of the entire name. Simply enter at least the first character of the column's name. Do not use a wild card character. For example, to locate the column `FIRSTNME`, enter `LOCATE F` in the `COMMAND` field. If the partial name qualifies more than one column, a window displays the matching column names allowing you to select one.

Primary Commands

Table 1. Primary Command Availability by Function

Primary Command	Browse	Edit	Table Mode	Row Mode	SQL Analysis ¹	Utilities	Relationships
ADD	x	x	x	x			x
BOTTOM	x	x	x	x	x	x	x
BROWSE	x	x	x	x	x	x	
CANCEL	x	x	x	x	x	x	x
CAPS	x	x	x	x			
CHANGE		x	x	x			
CUT		x	x				
DELETE		x		x			
DOWN	x	x	x	x	x	x	x
E	x	x		x			
EDIT	x	x	x	x		x	
END	x	x	x	x	x	x	x
EXCLUDE ALL	x	x	x				
EXECUTE						x	
EXPAND	x	x	x			x	
FADB2					x		
FIND	x	x	x	x			x
FLIP	x	x	x				
GO						x	x
GRAPHIC	x	x	x	x			x
HELP	x	x	x	x	x	x	x
HEX	x	x		x			
HIDE	x	x	x	x			
HOLD	x	x	x	x			
INFO	x	x	x	x	x	x	x
INSERT		x		x			
JUMP	x	x	x	x			
KEYLIST							x
KEYS	x	x	x	x	x	x	x
LEFT	x	x	x		x		
LOCATE	x	x	x	x		x	x
MAX	x	x	x	x			
MAXCOL	x	x	x	x			
MEMORY	x	x					
MIN	x	x	x	x			
MODE						x	x
NEXT	x	x		x			
PASTE		x	x				

Table 1. Primary Command Availability by Function (Continued)

Primary Command	Browse	Edit	Table Mode	Row Mode	SQL Analysis ¹	Utilities	Relationships
PATH	x	x	x	x			
PREV	x	x		x			
PRINTDS	x	x	x	x			
PRINTP	x	x	x	x			
PROFILE	x	x	x	x			
RBROWSE	x	x	x	x			
RCHANGE		x	x	x			
REDIT	x	x	x	x			
REPEAT		x		x			
RESET	x	x	x	x			
RETRIEVE	x	x	x	x	x	x	x
RETURN	x	x	x	x	x	x	x
RFIND	x	x	x	x			
RI ²		x		x			
RIGHT	x	x	x		x		
ROW	x	x	x				
ROWH	x	x	x				
SAVE		x	x	x	x		
SCHEMA ³					x		
SIZE	x	x				x	
SORT	x	x	x	x	x	x	x
SPLIT	x	x	x	x	x	x	x
SQL	x	x			x	x	
SQLID	x	x	x	x	x	x	x
SWAP	x	x	x	x	x	x	x
TABLE	x	x		x			
TOP	x	x	x	x	x	x	x
UDT	x	x	x	x		x	x
UDTSWAP						x	x
UDTTYPE						x	x
UP	x	x	x	x	x	x	x
V	x	x		x			
WRAP	x	x	x				
ZOOM	x	x	x				
ZOOMH	x	x	x				

¹ Unless otherwise noted, commands are available in SQL Source Analysis only.
² Valid only from the RI Browse window.
³ Valid only from the SQL Plan Analysis option.

Note: The following commands have been replaced by Object Administration functionality: ALTER, ATOMIC, COLCHECK, CREATE, DEFAULT, FOREIGN, GRANT, IDENTITY, MODIFY, NAMCHECK, PARS, PARTITN, PRIMARY, REMARKS, RETPARN, REVOKE, RUNOPTS, SRCPARM,

UDFOPTS, VALUES and WHENCOND. Refer to the *File-AID for DB2 Object Administration User Reference Manual* for more information.

The primary commands are listed alphabetically. Parentheses enclose command abbreviations. If no syntax is shown for a command, the command accepts no parameters.

ADD : Adds a new application relationship to the relationship file. Valid only in Related Table Browse and Edit and Option 6, Relationships.

BOTTOM (BOT) : Displays the last line of data in a selected object.

BROWSE (BRO) : Initiates a multiple browse session from a browse or edit session. The tables do not have to be related. In Option 3.4 (Object List Processing) and Option 4 (SQL Analysis), the BROWSE command will display DB2 catalog data when entered from a table, index, or trigger object information panel.

CANCEL (CAN) : Cancels the current activity or discards edits made since the last save.

CAPS : ON converts lowercase text to uppercase letters.

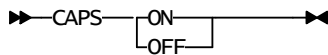

CHANGE (C) : Changes a value. If you do not enter a column name, the change is applied to all columns. Without the ALL parameter, only the first occurrence of a value is changed starting at the cursor position. Entering CHANGE with no parameters displays a selection window.

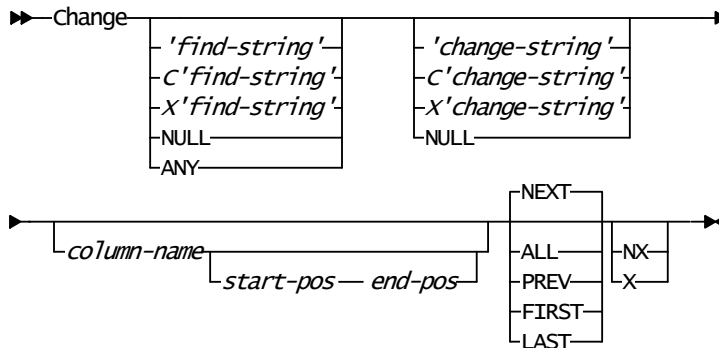

See "Partial Column Names" on page 3 for information on specifying column name.

CUT (CU) : Appends one or more rows from a table into the paste buffer. CUT REPLACE overwrites the current paste buffer. Valid only in Edit table mode.



DELETE (DEL) : Deletes one or more rows from a table. Valid only in Edit row mode.

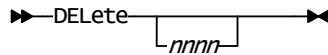

DOWN : Scrolls down by the specified amount.

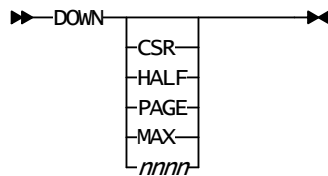

E : The E command displays the Edit Column Data screen for the selected column. There, you can edit the column data of one row in character image. Specify the desired column with its column number as it is displayed on the row mode screen, or place the cursor on the target column before you press ENTER. Valid only for character type column in Edit row mode.

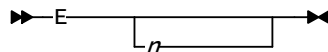

EDIT (ED) : Initiates a multiple edit session from a browse or edit session. The tables do not have to be related.

END : Ends the current File-AID *for DB2* activity and takes you back to the previous screen.

EXCLUDE (X) : Excludes rows from an Edit display.



EXECUTE (EXEC) : Processes your request for data selection.

EXPAND : The EXPAND command enables you to view the full content of a scrollable field in a separate window.

FADB2 : Blank executes the indicated SQL Analysis line command: BR, ED, EX, or XP. BOUNDS returns a message stating the status of column boundaries.

Entering column positions sets new column boundaries. Valid only from the SQL Analysis Edit screen.

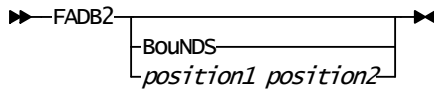

FIND (F) : Searches for occurrences of a specified value within a column, displays a message stating the total number, and moves the cursor to the first occurrence. If you do not specify a column name, the search applies to all columns. Without the ALL parameter, only the first occurrence of a value is found starting at the cursor position. Entering FIND with no parameters displays a selection window.

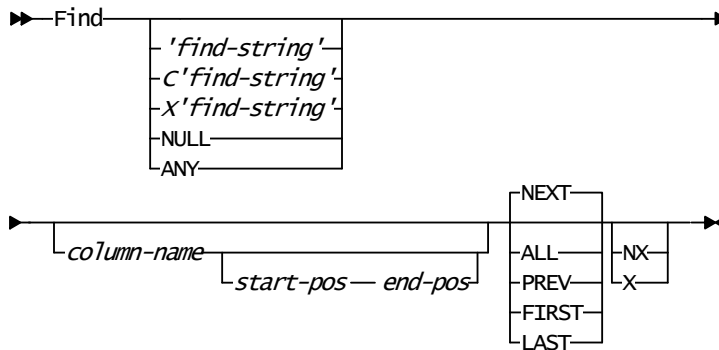

See “Partial Column Names” on page 3 for information on specifying column name.

FLIP : Makes excluded rows visible and visible rows excluded. You must have excluded rows in the Edit display for this command to be effective.

GO (G) : Submits an extract or load request from either the “Extract DB2 - Driving Object”, “LOAD - SQL Insert”, or “LOAD - DB2 Load” panels.

GRAPHIC (GR) : Displays a graph of the tables related to the table you are browsing or editing.

HELP : Invokes the File-AID *for DB2* help facility, causing a help screen or message to be displayed. When an SQL error is displayed, the HELP command provides the DB2 SQL error text returned from DB2.

HEX : Displays data in hexadecimal format. Valid in zoom and row mode.

HIDE : Causes one or more columns to be hidden from a Browse or Edit display. Entering HIDE with no parameters displays a column selection list. Columns remain hidden until the RESET command is issued.

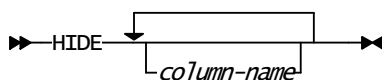

See “Partial Column Names” on page 3 for information on specifying column name.

HOLD : Causes one or more columns to be fixed to the left side of the table mode screen or to the top of the row mode screen. Entering HOLD with no parameters displays a column selection list. Columns remain held until the RESET command is issued.

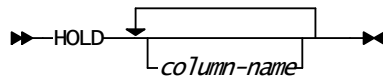

See “Partial Column Names” on page 3 for information on specifying column name.

INFO : Displays the current File-AID for DB2 Location ID, Subsystem ID, SQL ID, User ID, Plan name, ISPF applid, and File-AID for DB2 and DB2 versions.

INSERT (INS) : Inserts one or more new rows into a table. Valid only in Edit row mode.

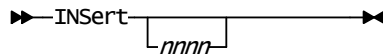

JUMP (J) : Allows you to edit another table when editing multiple tables. When you jump to a new window, it becomes active. Defaults to the next sequential window.

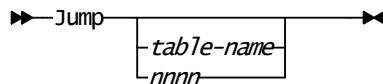

KEYLIST : Enter the ISPF Key List utility. ON and OFF valid only with ISPF 4.1 or above.

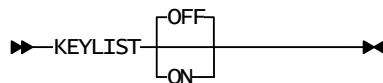

KEYS : Displays the default PF key settings.

LEFT : Scrolls left by the specified amount.

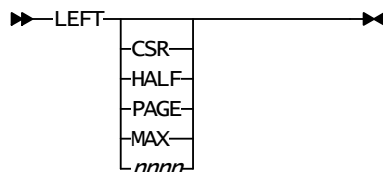

LOCATE (L) : In Browse or Edit mode, scrolls the screen to position the display at a specified column. Entering LOCATE with no parameters displays a column selection list.

►►Locate column-name ◄◄

See “Partial Column Names” on page 3 for information on specifying column name.

From an object list, searches for a value in a selection list.

►►Locate *value* ◄◄

MAX : Enlarges a window to the maximum screen size when viewing multiple tables.

MAXCOL : The MAXCOL command sets the maximum width of the columns in the DB2 table being browsed or edited to the value specified. This command only affects the following column data types: CHAR, VARCHAR, LONG VARCHAR, GRAPHIC, VARGRAPHIC, LONG VARGRAPHIC, BLOB, CLOB, and XML. MAXCOL for a DB2 table defaults to OFF.

When you set MAXCOL in a browse or edit session (or related browse/edit), that setting is retained across sessions. So, if you exit a session and then later start a new session, the setting remains the same. You can change the setting from the browse/edit screen, or from Option 0, Defaults and User Params, at the Primary Option Menu.

►►Maxcol n
OFF ◄◄

Note: If MAXCOL is set when a FIND, RFIND, CHANGE or RCHANGE command is executed, File-AID *for DB2* turns MAXCOL to OFF.

MEMORY (MEM) : The MEMORY command allows you to provide information to File-AID *for DB2* so that the proper amount of memory can be used to execute specific commands. MEMORY is available from the following screens:

- Edit Options
- Browse Options

►►MEM ◄◄

MIN : Reduces a window to its original size when viewing multiple tables. You can then resume viewing multiple tables.

MODE : The MODE command switches the extract or load execution mode from BATCH (default) to ONLINE or from ONLINE back to BATCH. MODE acts as a toggle switch. Valid in the “Extract DB2 - Driving Object” and “LOAD - SQL Insert” panels.

NEXT (N) : Scrolls the display from the current row to the next row. MAX scrolls to the last row in the table. Valid only in row mode.

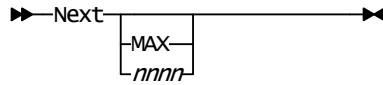

PASTE (PAS) : Copies one or more rows from the paste buffer into a table or dataset. Valid only in Edit table mode.

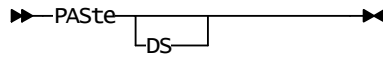

PATH : Switches to another dependent table path from the current parent table. Valid only in Related Edit mode.

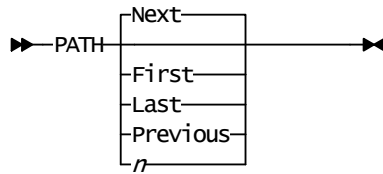

PREV (P) : Scrolls the display from the current row to the previous row. MAX scrolls to the first row in the table. Valid in row mode.

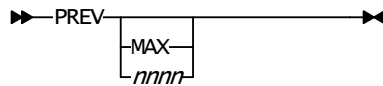

PRINTDS (PRTDS) : Prints rows displayed or specified on the screen, or in a table or view. Output is appended to the dataset that you specify in Option 0.7, Print Options.

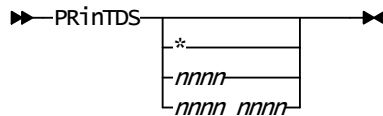

PRINTP (PRTP) : Prints one or more rows to the printer specified in Option 0.7, Print Options.

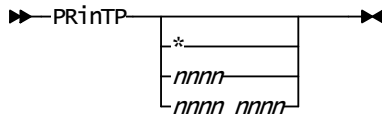

PROFILE (PRO) : Displays a window with your current profile options and allows you to change them. See “User Profile Defaults” on page 17 for a list of options you can set with this command.

RBROWSE (RB) : Initiates a Related Browse session. Browses the table related to the table you are browsing or editing. Specifying ADD allows you to add a new application relationship.



RCHANGE : Repeats the execution of the previous CHANGE command.

REDIT (RE) : Initiates a Related Table Edit session. Edits the table related to the table you are browsing or editing. Specifying ADD allows you to add a new application relationship.



REPEAT (REP) : Adds one or more duplicate rows to a table. Valid only in row mode. If Repeat Command Prompt Option of the PROFILE command is set to ON, and the table does not contain Unicode table data, the REPEAT Column Range Specification window appears.

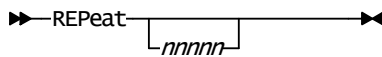

RESET (RES) : Restores hidden and held columns, and excluded and blank inserted lines. Entering RESET with no parameters displays a column selection list.

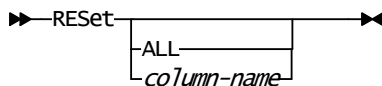

See “Partial Column Names” on page 3 for information on specifying column name.

RETRIEVE : Redisplays the last command entered in the COMMAND field.

RETURN : Returns to the File-AID *for DB2* Primary Option Menu or to the screen displayed when you entered the HELP command.

RFIND : Repeats the execution on of the previous FIND command.

RI : Resolves referential integrity errors. Valid only in RI Browse row mode.

RIGHT : Scrolls to reveal data to the right of the display.

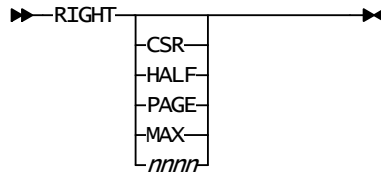

ROW : Switches a Browse or Edit display from table to row mode. Position cursor on row to be displayed before pressing Enter.

ROWH : Switches a Browse or Edit display from table to hexadecimal row mode. Position cursor on row to be displayed before pressing Enter.

SAVE : Makes your editing changes permanent.

SCHEMA : The SCHEMA command changes the value of the CURRENT SCHEMA during an SQL Analysis session, without returning to the User Params menu. When you enter the SCHEMA command, the same screen is displayed as when you select CURRENT SCHEMA from the Special Registers Values menu.

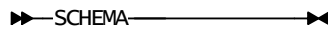

SIZE : The SIZE command provides an alternate display of the selection template in a browse/edit, extract or print session. It allows 58 positions of the WHERE clause to be displayed, and does not include all of the lines on the original display. The alternate display is designed to maximize the amount of rows displayed on the panel, so that you have a larger area to build a WHERE clause.

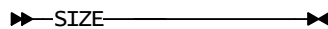

SORT : In Browse or Edit, sorts the rows of a table by the specified column. Entering SORT with no parameters displays a column selection list. Defaults to sorting only non-excluded rows. Specify ALL for all rows.

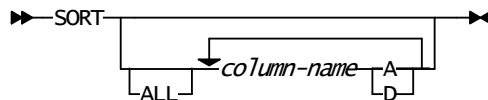

See "Partial Column Names" on page 3 for information on specifying column name.

From an object list, sorts the list by the specified criteria.

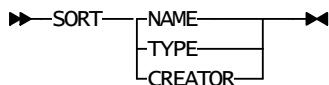

You can also issue SORT on SQL Development and Analysis selection screens.

SPLIT : Divides the display screen, letting you run two sessions simultaneously.

SQL : Presents the DB2 SQL statements generated for the displayed screen.

SQLID : Sets your SQLID to a new value.

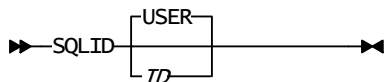

SWAP : Moves the cursor to the last position it occupied in the opposite screen of a split-screen session.

TABLE (TAB) : Switches a Browse or Edit display from row mode to table mode.

TOP : Displays the first line of data in a selected object.

UDT : Displays the schema.name and its built-in datatype for the selected User Defined Type (UDT) column (cursor position). Edit/Browse only.

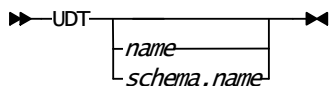

UDTSWAP : Swaps the display for distinct type columns from UDT name to the built-in data type and length and vice versa. Valid only on the (Extract) "DB2 Object Selection Criteria" screen.

UDTTYPE : Lists all distinct data types (UDTs) that are part of the extract. The list displays the schema, UDT name, and the built-in data type and length. Valid only on the (Extract) "DB2 Object Selection Criteria" screen.

UP : Scrolls up by the specified amount.

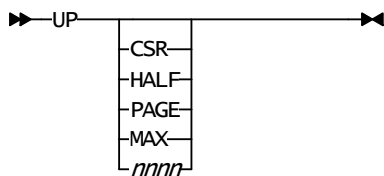

V : The V command displays the Edit Column Data screen for the selected Unicode column. The entire value of the column is displayed vertically with

one character per line. There, you can edit the column data of one row in hexadecimal image. Each character is identified by its Unicode hex value and its description. Specify the desired column with its column number as it is displayed on the row mode screen, or place the cursor on the target column before you press ENTER. Valid only for Unicode column in Edit row mode.

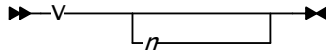

WRAP : ON or *nnnn* wraps column data so it is visible without scrolling left or right. Valid in table mode only, after issuing a ZOOM or ZOOMH command.

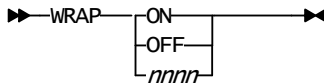

ZOOM : Allows viewing of a specific column in character format. Valid only in table mode.

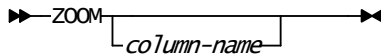

See “Partial Column Names” on page 3 for information on specifying column name.

ZOOMH : Allows viewing of a specific column in hexadecimal format. Valid only in table mode.

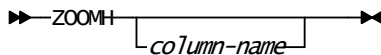

See “Partial Column Names” on page 3 for information on specifying column name.

Line Commands

Table 2. Line Commands

Line Command	Edit table mode	Browse table mode	ZOOM and ZOOMH mode	SQL Source Analysis
A	x			x
B	x			x
BR				x
C, CC	x			x
D, Dn, DD	x			x
ED				x
EX				x
I, In	x			x
M, MM				x
R, Rn, RR	x			x
RI ¹	x			
S, Sn	x	x	x	x
X, Xn, XX	x	x	x	x
XP				x

¹Valid only from the RI Browse window.

Note: The FADB2 primary command must be executed to execute line commands BR, ED, EX, and XP.

User Profile Defaults

Table 3. Options Set with the PROFILE Primary Command

Option	Description
AUTOCOMMIT	Specify ON to commit changes each time you press Enter during an Edit session.
AUTOSAVE	Specify ON to save changes each time you press END (PF3) during an Edit session.
CAPS	Specify ON to automatically change all data entered in lowercase characters to uppercase characters.
OBJECT NAMES UPPERCASE	Specify ON to automatically change all object names entered in lowercase characters to uppercase characters.
MAXROWS	Specify a numeric value or an asterisk (*) to denote the number of rows to be selected. You can also change this value for individual Browse or Edit sessions.
NON-DISPLAY	Specify the character that File-AID for DB2 uses to signify nondisplayable data in browse mode.
NULL ENTRY	Specify the character that, when entered, sets a column to null.
NULL DISPLAY	Specify the character that appears for null columns.
SPACES IMPLY NULL	Specify ON to have spaces imply nulls for character columns.
VARIABLE LENGTH MARK	Specify the character used to indicate the end of a column.
UPDATE PRIMARY KEY	Specify ON to update primary keys during an Edit session.
SHOW FOREIGN KEYS	Specify ON to show foreign keys during an Edit session. Foreign Key information is only shown for local tables. Because DB2 does not maintain an index on the table containing foreign key information, setting this option to ON may have a negative impact on performance.
VARIABLE LENGTH TRUNCATE	Specify ON to truncate trailing spaces on an insert or update during an Edit session.
INSERT DT/TM/TS TRUNCATE	Specify date/time format used as a default value when you enter date, time, or timestamp in NOT NULL WITH DEFAULT field by using CURRENT. Specify Local or GMT (Greenwich Mean Time).
RETRIEVE UNIQUE KEY INFO	Specify ON to retrieve unique key information before the Edit session begins. This value applies only if there is no primary key. Unique key information is only retrieved for local tables.
REPEAT COMMAND PROMPT	Specify ON to display the REPEAT Column Range Specification window for the REPEAT primary or line command. Specify OFF to suppress the pop-up window. Does not apply when editing Unicode table data.
UPDATE IDENTITY COLUMN	Specify ON to allow update of identity columns in edit. This applies only to columns set to GENERATED BY DEFAULT. Columns set to GENERATED ALWAYS cannot be edited. If the column is both an identity column and a primary key, then UPDATE PRIMARY KEY must also be ON to edit the column.
MAX SIZE LOB RETRIEVED	Specify the maximum byte size of LOB data that can be retrieved in a table being browsed or edited. The setting only affects BLOB, CLOB, and XML data types. Valid values are 1 through 4096. The value cannot exceed your site configured MAXLOB size.

Object Administration

Without coding SQL or JCL, you can create, alter, and drop DB2 objects and much more. The user interface for Object Administration is a window-like interface within ISPF, whereas the rest of *File-AID for DB2* is an ISPF user interface.

This section provides a summary of the Object Administration conventions and work buffers. It also provides the syntax of its primary commands and row commands.

Notation Rules

- All keywords are shown in UPPERCASE characters and must be spelled exactly as shown. You cannot substitute another value.
- All variables are user-specified values and are printed in lowercase italics. For example, *dataset-name* indicates you are to substitute a value.
- Default PF key values are shown within angle brackets, such as <Help>.

Reading the Syntax Diagrams

The syntax for Object Administration commands is described in diagrams that help you visualize parameter use. The following example shows a command and a parameter:

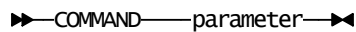

Read the diagrams from left to right and from top to bottom. Required parameters appear on the horizontal line (the main path). Optional parameters appear below the main path. Default parameters appear above the main path; including them in the command is optional:

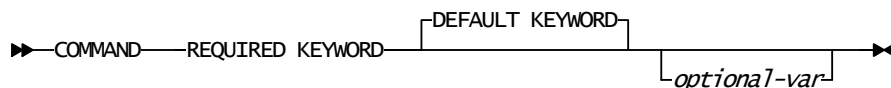

Vertically stacked parameters are mutually exclusive. If you must choose a parameter, one item of the stack appears on the main path. If the parameters are optional, the entire stack appears below the main path.

Conventions

The following conventions for Object Administration conventions are explained in this section:

- Implicit selection of a command or function
- PF key assignments
- Help
- Managing windows

Implicit Selection

You can select a command or function by moving the cursor to a window element and pressing Enter. These elements provide implicit selection:

- Any item under a column heading of **Command**.
- Top border — executes a GO command.
- Bottom border — executes an END command.
- COMMAND prompt — rotates MINIMIZE, MAXIMIZE, and NORMALIZE commands.
- Scroll characters represent a scroll amount and direction:

<code>< of <\\/\></code>	Scrolls left by the scroll field amount.
<code>\ of <\\/\></code>	Scrolls down by the scroll field amount.
<code>/ of <\\/\></code>	Scrolls to the bottom.
<code>/ of <\\/\></code>	Scrolls to the top.
<code>\ of <\\/\></code>	Scrolls up by the scroll field amount.
<code>> of <\\/\></code>	Scrolls right by the scroll field amount.
<code>. (period)</code>	Represents invalid scroll direction.

Default PF Key Assignments

Table 4. Default Program Function Keys

PF Key	Command	PF Key	Command
PF1	HELP / Smart Link access	PF13	MENU
PF2	SPLIT	PF14	GO
PF3	END	PF15	CANCEL
PF4	EXIT	PF16	RETRIEVE
PF5	RFIND	PF17	FREEZE
PF6	RCHANGE	PF18	HIDE
PF7	UP	PF19	PREVIOUS
PF8	DOWN	PF20	NEXT
PF9	SWAP	PF21	JUMP
PF10	LEFT	PF22	LEFT MAXIMUM
PF11	RIGHT	PF23	RIGHT MAXIMUM
PF12	MAXIMIZE	PF24	NORMALIZE

Finding Help

Object Administration offers extensive Help facilities, listed below. The default PF key for <Help> is PF1.

Help Menu : To display the Help Menu, select HELP from the Main Menu. The fast-path command is MENU.HLP, which you can execute in any window.

Tutorial : Select TUTORIAL from the Help Menu.

Valid Row Commands : To display valid row commands for any window, place the cursor in the number sequence area and press <Help>. Help for row commands can also be accessed with the HELP row command.

Valid Primary Commands : To display valid primary commands for any window, place the cursor on a blank COMMAND field and press <Help>.

Command Syntax and Help Text : To display syntax and usage instructions for a primary command, first open the window of valid primary commands. Place the cursor on the description text for a command and press Enter.

Command Placement : If you select a command from the Command Help window, Object Administration places it in the *requesting* window and closes all Help windows. The requesting window is the one in which the cursor was located when you pressed <Help>.

Parameter Values : To find valid values for a parameter field, place the cursor on the field and press <Help>. A window opens showing valid values. If you select a value from this window, Object Administration places the value in the field and removes the Help windows. Step-by-step instructions are in *File-AID for DB2 Object Administration User Reference Manual*.

Smart Link : If you press <Help> on a field that requires a DB2 catalog object name, Smart Link automatically invokes the appropriate catalog display facility for you. When you locate the object name and select it, Smart Link places it in the parameter field and closes all Help windows.

DB2 Catalog Help : To find out what a column's relationship is to the DB2 catalog, place the cursor on the column's heading and press <Help>. In the Column Attributes window that opens, look for DB2 TABLE NAME and DB2 COLUMN NAME.

Window Help : Many windows have specific online instructions available. Enter HELP WINDOW in the COMMAND field or place the cursor on the top border and press <Help>. If no window-specific Help is available, the Help Menu window opens.

Managing Windows

Executing : Windows with contents that can be executed have a “GO” to Execute message in the top border. To execute the window's contents:

- Execute the GO primary command.
- Press the PF key assigned to GO. The default is PF14.
- Place the cursor on the top border and press Enter.

Maximizing : To make the window as large as your screen:

- Execute the MAXIMIZE primary command.
- Press the PF key assigned to MAXIMIZE. The default is PF12.
- Use the toggle function of the COMMAND prompt.

Minimizing : To make the window small:

- Execute the MINIMIZE primary command.
- Use the toggle function of the COMMAND prompt.

Normalizing : To return the window to its normal size:

- Execute the NORMALIZE primary command.
- Press the PF key assigned to NORMALIZE. The default is PF24.
- Use the toggle function of the COMMAND prompt.

Ending : To remove a window and save changes:

- Execute the END primary command.
- Press the PF key assigned to END. The default is PF3.
- Execute the REMOVE command (descendants remain).
- Place the cursor on the bottom border and press Enter.

Canceling : To remove a window and delete changes:

- Execute the CANCEL primary command.
- Press the PF key assigned to CANCEL. The default is PF15.

Exiting : To terminate your Object Administration session:

- Execute the EXIT, END, or CANCEL primary command in the Main Menu.
- Press the PF key assigned to EXIT. The default is PF4.
- Execute the QUIT primary command in any window.

Controlling Columns

- Scroll columns by using <Right> or <Left> or by using the scroll characters left arrow (<) and right arrow (>).
- Prevent columns from scrolling with the FREEZE primary command. Use the cursor to point to a column.
- Exclude columns from display with the HIDE primary command. Use the cursor to point to a column.

Column List Window

To open this window, use the FREEZE or HIDE command without pointing to a column with the cursor.

A	Inserts column after
B	Inserts column before
CLR	Clears (thaws) or unexcludes column
F	Freezes a column from scrolling
H	Hides (excludes) a column from display
M	Moves column to specified destination

Generating Vertical Displays

Any row in any window can be displayed in a separate vertical display window by using the V (vertical) row command. In the vertical display window, use <Next> to display the next row and <Previous> to display the previous row.

Customizing Window Placement

You can customize the placement of any window that normally opens with its upper-left corner at the cursor. Use the window placement values in your user profile:

MAX COLUMN and MAX ROW : Threshold values for the upper-left window corner. If the window normally opens to the right or below these values, it will instead open at the OPEN COLUMN and OPEN ROW coordinates.

OPEN COLUMN and OPEN ROW : Coordinates at which the window is placed.

Access these values in the Window Parameter Display and Edit window. The fast-path command is MENU.PRO.WIN.

Window Hierarchies

The relationships between windows are important when you execute certain commands. For example, when you remove a window, you can either remove the window alone or remove the window and its descendant windows. This section shows you how to determine a window's current relationship to other windows.

In the upper-right corner of each window is a **level number** that indicates its place in the window hierarchy. When you open another window, that new window is a **descendant**. The window from which it was generated is the **parent** window.

The first Main Menu is always level 1. All other level numbers are two digits in the form x.y, where x is the sequence number and y indicates its parent window.

For example, the first descendant of the Main Menu is always 2.1: the 2 indicates it's the second window opened. The 1 indicates the parent window's sequence number (level 1). If you generate a window from 3.1, its level is 4.3. Figure 1 shows several more examples.

Figure 1. Example of Descendant Windows

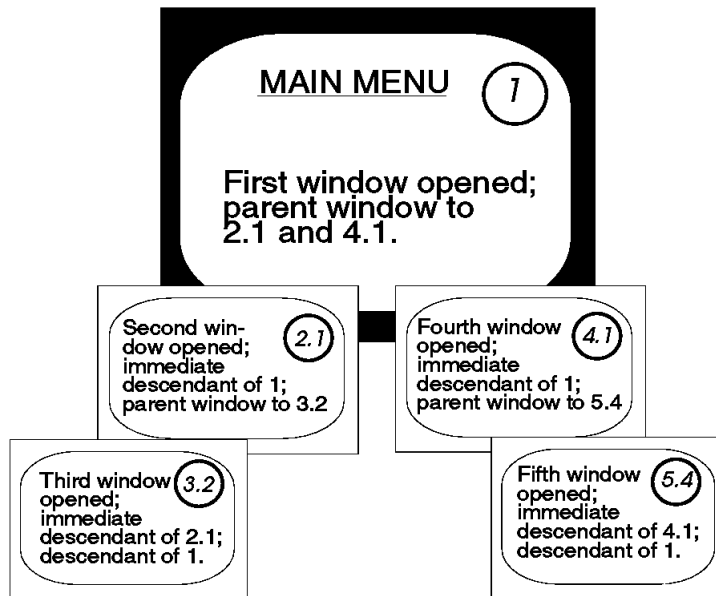

Creating a Fast-Path Command

A fast-path command opens a specific window by automatically opening all the necessary windows.

To create a fast-path command, concatenate the selection commands from the Command column in each window you want to open. Use periods (.) as delimiters. The following example shows how to access the Edit Unit Table window:

```
MENU.PRO.US
```

Command for User selection

Command for Profile selection

Command for Main Menu

The MENU prefix is not necessary if you are executing the command in the Main Menu.

Primary Commands

All commands and keywords can be abbreviated as long as they can be uniquely identified. Not all commands are available in all windows. Restrictions are noted. Commands without syntax diagrams have no parameters.

Note: These commands are valid for the latest version of DB2. If you have an earlier version of DB2, some commands may not be available.

ACTIVATE : Generates SQL to activate row-level and/or column-level access control. It displays the Activate Row and or Column Access Control window. Valid from the TABLE ALTER display.

ADD_VERSIONING : The Generates SQL to specify that the table is a system-period temporal table. ADD_VERSIONING generates the ADD VERSIONING USE HISTORY TABLE clause to the ALTER TABLE statement. If no history table exists for the temporal table, it displays the Edit Create HISTORY Table Information window. Valid from the TABLE ALTER display.

ADD_CLONE : Displays the ADD CLONE Tables Display window. Valid from the Table Alter display.

ALTER : Generates SQL to alter an object in a create object editing window. Valid in index, storage group, and tablespace object editing windows.

ARRANGE : Arranges the display of windows.

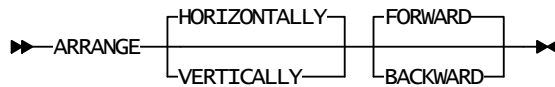

BATCH : Copies SQL statements into the JCL work buffer for batch submission.
Valid in SQL work buffers.

BIND : Generates statements for the BIND DSN subcommand. Valid for packages and plans. Also available as a row command.

BROWSE : Invokes the ISPF/PDF browse function.

CALC : Calculates space requirements. Valid in object editing windows for indexes, tables, and tablespaces. Also available as a row command.

CANCEL : Removes a window and its descendants. Deletes statements or commands appended to a work buffer.

CAPS : Controls the uppercase translation of the input data.

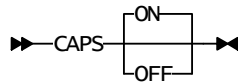

CAPTURE : Saves the rows of a table to a dataset.

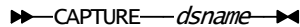

CHANGE : Locates a string and changes it.

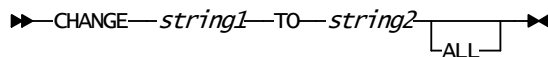

CL (Columns) : Displays associated columns. Valid in the Index Display Window.

CLEAR : Deletes all rows in a window.

COMMIT : Establishes a commit point.

CONNECT : Specifies a location for databases to be accessed through application-directed access.



CONSTRAINTS : Defines unique constraints for a table. Valid in table object editing windows.

CRAL : Generates SQL to create an alias. Valid for tables and views. Also available as a row command.

CREATE : Generates SQL to create an object in a create object editing window. Valid in index, storage group, table, and tablespace object editing windows.

CRMQ (CREATE MQT for Group of Tables (join)) : Generates SQL to create Materialized Query Tables. This command is valid for table lists. When entering the command, the Edit Create MQT for Tables outer and inner windows display listing columns from all of the Tables in the list. To generate CREATE SQL from a single table, use the CRMQ row command.

CRSY : Generates SQL to create a synonym. Valid for tables and views. Also available as a row command.

CRVW : Generates SQL to create a view for a group of tables. Valid for tables. Also available as a row command.

CUT : Captures data and places it in a buffer.



DB : Displays databases related to objects. Valid for indexes, tables, tablespaces, and sets. Also available as a row command.

DBRM : Opens the database request module (DBRM) windows. Valid in the Edit Plan Params window.

DCL : Generates declare statements (DCLGEN). Valid for tables and views. Also available as a row command.

DEACTIVATE : Generates SQL to deactivate row-level and/or column-level access control. It displays the Deactivate Row and or Column Access Control window. Valid from the TABLE ALTER display.

DOWN : Scrolls the window contents down.

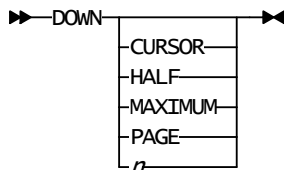

DROP : Generates SQL to drop an object. Valid in index, storage group, table, and tablespace object editing windows. Also valid for packages.

DROP_CLONE : Generates an ALTER TABLE SQL statement to drop the Clone Table from its base table. Valid from the Table Alter display.

DROP_VERSIONING : Generates SQL that specifies that the table is no longer a system-period temporal table. It generates an ALTER TABLE statement with only a DROP VERSIONING clause. It does not delete the history table. Valid from the TABLE ALTER display.

EDIT : Invokes the ISPF/PDF edit function.

END : Removes a window and its descendants; changes are saved, creating a commit point. Saves statements or commands appended to a work buffer if the Clear Work Buffer setting in your user profile is set to NO.

EXCHANGE : Displays the EXCHANGE CLONE Data Display window. Valid from the Table Alter display.

EXIT : Closes all windows in a navigation path.

FIND : Locates a string and scrolls it into view.

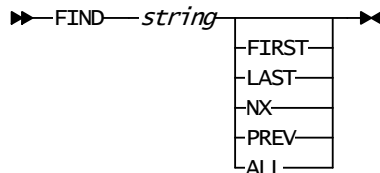

FINISH : Synonym for END.

FREE : Generates statements for the FREE DSN subcommand. Valid for packages and plans. Also available as a row command.

FREEZE : Selects columns to be excluded from scrolling. Use the cursor to select the column. If you do not select a column, the Column List window opens.

GO : Executes the window's contents or signals a change to the next window or commits changes.

GRANT : Generates GRANT SQL statements. Valid for columns, databases, packages, plans, routine authorizations, schema authorizations, tables, tablespaces, users, and views.

HELP : Invokes the Help Facility.

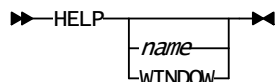

HIDE : Hides (excludes) a column from display. Use the cursor to select the column. If you do not select a column, the Column List window opens.

HOLD : Invokes an ISPF session; File-AID is put on hold.

INSERT : Inserts blank rows.

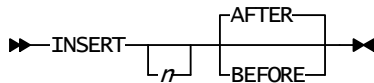

IP : Displays related index partitions. Valid for indexes. Also available as a row command.

IPH : Displays related index partition history. Valid for indexes, index partitions, and index history. Also available as a row command.

IX : Displays related indexes. Valid for databases and tables. Also available as a row command.

IXH : Displays related index history. Valid for indexes and table history. Also available as a row command.

JUMP : Moves the cursor to the next COMMAND field.

KEEP : Keeps the contents of the work buffer and ends the window regardless of the CLEAR WORK BUFFERS setting in your Window Display Parameter profile.

KEYS : Displays PF key assignments.

KT (Key Targets) : The KT primary command displays the Key Targets window. It displays the rows from SYSKEYTARGETS which is populated when an expression is used to create the Index. Valid from the Index List display and from the Detail Display of INDEX.

LABELS : Lists active row labels. Use the list to scroll labeled rows.

LEFT : Scrolls the window contents left.

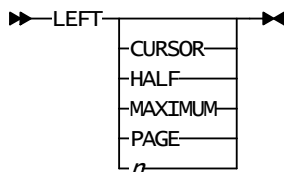

LIMITKEY : Displays the Edit Limitkeys window where you can edit the limit key values for each partition. Valid in the Edit Table Information windows.

LK (Limitkeys) : Displays limit key values for all tables in a window. This command is valid for tables. Also available as a row command.

LOAD : Generates JCL for the LOAD utility. Valid for tables.

LOCATION : Specifies a location for databases to be accessed through system-directed access.

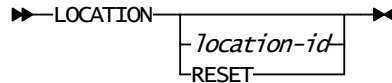

MAXIMIZE : Resizes a window to the size of the screen.

MENU : Displays the File-AID Main Menu.

MINIMIZE : Resizes a window as small as possible and hides descendant windows.

NEXT : Displays the next row in a vertical display window.

NORMALIZE : Returns a window to normal size and displays hidden descendant windows.

ORDER : Changes the sort sequence of the rows for any object display.

PACKAGES : Finds packages for displayed object. Valid for aliases, indexes, synonyms, tables, tablespaces, and views.

PASTE : Pastes data captured by a CUT command.

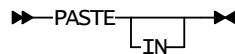

PATH : Displays current path.

PDSSAVE : Saves column into a dataset.

PKCOPY : Opens the Edit Package Copy Parms window. Valid in the Edit Package Bind Parms window.

PKL : Displays the package list. Valid in the Edit Plan Parms window. Also available as a row command.

PKLOC : Permits global changes to package location. Valid in the Edit Package Parms window.

PKS : Opens the Edit Package System Parms window. Valid in the Edit Package Parms window. Also available as a row command.

PLANS : Finds plans for displayed object. Valid for aliases, indexes, synonyms, tables, tablespaces, and views.

PLCON : Generates statements to convert DBRMs in a plan to packages. Valid for plans. Also available as a row command.

PLS : Displays the system list. Valid in Edit Plan Parms window. Also available as a row command.

POSITION : Places a window at a specified location.

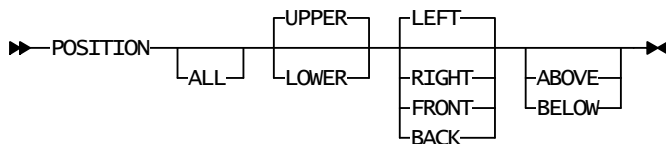

PREFIX : Opens a window for assigning a column prefix. Valid in create view object editing windows.

PREVIOUS : Displays the previous row in a vertical display window.

PRINT : Prints the contents of a window. Valid in impact report windows and object displays.

QUIT : Terminates your File-AID session.

REBIND : Generates statements for the REBIND DSN subcommand. Valid for packages and plans. Also available as a row command.

RCHANGE : Repeats a previous change command.

RELOAD : Refreshes pattern buffers.

REMOTE : Pops up a list of valid remote locations. Valid in the SQL work buffer and Edit Saved Query windows.

REMOVE : Deletes a window; descendants remain.

REPLACE : Replaces a member or query. Valid in PDS member window and the Edit Query window.

RESET : Resets pending row commands, displays excluded rows or hidden columns, and releases (thaws) frozen columns.



RETRIEVE : Lists previously executed commands.

REVOKE : Generates REVOKE SQL statements. Valid for routine authorizations, schema authorizations, user authorizations and in the revoke impact report window.

RFIND : Repeats previous FIND command.

RIGHT : Scrolls the window contents right.

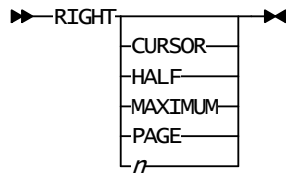

ROLL : Undoes changes since the last commit point.

ROTATE (Rotate Partitions) : ROTATE is valid in the Alter Table outer window. The ROTATE command is only valid for partitioned objects. It allows to rotate partitions for table-controlled partitioning tables. Rotating a partition allows a partition to be reused by a different set of data. The existing data in the partition is deleted and the partition is rolled to a new location for reuse.

ROW : Positions a row at the top of the window.

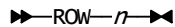

RT : Displays table relationships based on all objects in a set. Valid in the Edit Set Name and Options window.

RTS (Real Time Statistics) : Displays related real time statistics for all objects listed in the window. This command is valid for databases, indexes, and tablespaces.

To display related real time statistics for a single object, use the RTS row command.

SAVE : Saves window contents:

- Saves data into a member
- Saves a WHERE into a member
- Saves JCL into a member
- Saves DCLGEN into a member.

SCHEMA (Change CURRENT SCHEMA) : The SCHEMA primary command allows you to specify a value for the CURRENT SCHEMA Special Register. It functions like the SQLID command; the value specified with the command will set the value of the Special Register.

If no value is specified for CURRENT SCHEMA, it will default to the value specified for SQLID.

The value entered for CURRENT SCHEMA will be retained across sessions by DB2 subsystem. To check the current SCHEMA at any time, use the SHOW

command with the SCHEMA keyword. To reset your current SCHEMA to your SQLID, execute SCHEMA without a parameter.

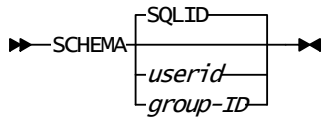

SELECT : Redisplays a WHERE clause for any object display.

SG : Displays storage group details. Valid for databases, indexes, index partitions, tables, tablespaces, tablespace partitions, and volumes. Also available as a row command

SHOW : Opens a work buffer or a window of current settings.

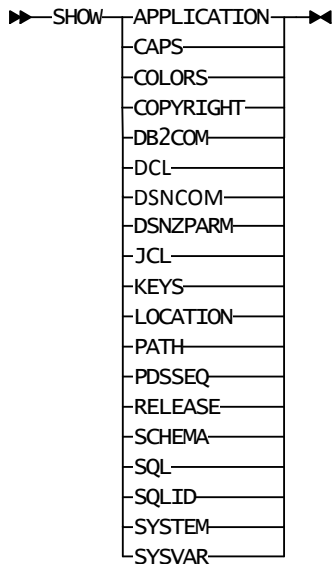

SORT : Changes the sort sequence of the rows for any object display.

SPF : Displays the ISPF/PDF COMMAND field.

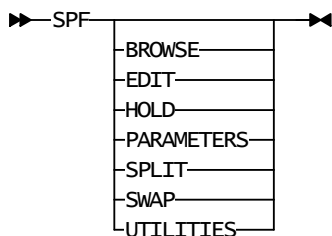

SPLIT : Invokes another ISPF session.

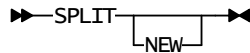

SQL : Executes SQL and DDL. Valid in the PDS member window.

SQLID : Changes the default SQL ID.

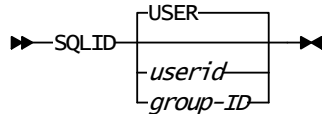

SUBMIT : Submits JCL for processing. Valid in the JCL work buffer.

SWAP : Swaps concurrent File-AID and ISPF sessions.

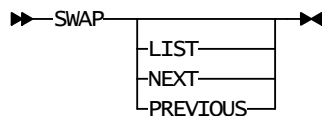

SWITCH : Switches status of excluded and unexcluded rows.

SY : Displays related synonyms. Valid for tables. Also available as a row command.

TB : Displays related tables. Valid for databases, indexes, tablespaces, and sets. Also available as a row command.

TBH : Displays related table history. Valid for tables and index history. Also available as a row command.

TP : Displays related partitions. Valid for tablespaces. Also available as a row command.

TPH : Displays related partition history. Valid for tablespaces. Also available as a row command.

TRACE : Controls the tracing function.

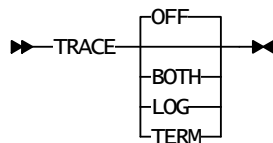

TR : Displays related triggers. Valid for tables. Also available as a row command.

TS : Displays related tablespaces. Valid for databases, indexes, tables, and sets.
Also available as a row command.

TSO : Executes a TSO command.

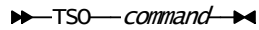

UP : Scrolls the window contents up.

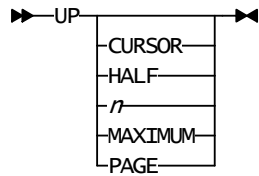

VW : Displays related views. Valid for tables. Also available as a row command.

WINDOW : Moves windows.

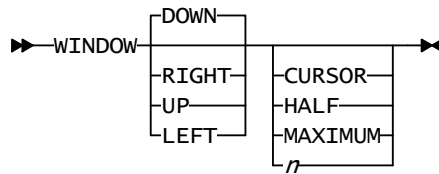

X : Excludes rows from display.

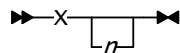

XMT : Displays the XML Tables Display window. valid from the XML Relations of TABLE displays.

XT : Displays the auxiliary table for a base table. Valid for auxiliary relationships.
Also available as a row command.

ZOOM : Toggles the display width of a column. Use the cursor to select a column to zoom.

Row Commands

Note: These commands are valid for the latest version of DB2. If you have an earlier version of DB2, some commands may not be available.

ACT : Generates SQL to activate row-level and/or column-level access control. It displays the Activate Row and or Column Access Control window. Valid from the Table display.

AL : Displays related aliases. Valid for locations, tables, and views.

ALL : Displays all privileges for the grantee. Valid for distinct routine authorizations, distinct schema authorizations, routine authorizations, schema authorizations, and user authorizations.

ALT : Generates SQL to alter an object. Valid for bufferpools, databases, indexes, storage groups, stored procedures, tables, and tablespaces. For bufferpools, ALT generates -ALTER BUFFERPOOL DB2 command statements.

AR : Displays auxiliary objects for large objects. Valid for columns and tables.

BIND : Supports the BIND DSN subcommand. Valid for packages and plans.

CA : Displays column update authorizations. Valid for columns, distinct routine authorizations, distinct schema authorizations, packages, plans, tables, table users, column users, and views.

CALC : Calculates object space requirements. Valid for indexes, tables, and tablespaces.

CB : Displays Created By Selection Menu. Valid for distinct routine authorizations, distinct schema authorizations, routine authorizations, schema authorizations, and users.

CD : Displays check dependencies against a column or table. Valid for columns and tables.

CF : Displays cast functions for a user defined data type (DISTINCT type). Valid for user defined data types.

CK : Displays check constraints against a table. Valid for tables.

CL : Displays object columns. Valid for column users, indexes, tables, user-defined data types, and views.

CLDIST : Displays statistics from catalog. Valid for columns.

CLH : Displays related columns history. Valid for tables history and columns.

CLR : Resets (thaws) column frozen by the FREEZE command or resets column statistics. Valid in the Column List window.

CLU : Displays unique constraint table columns. Valid for tables.

CM : Generates SQL to update comments. Valid for aliases, columns, indexes, packages, plans, sequences, stored procedures, tables, triggers, user-defined data types, and views.

- CN** : Displays the collection. Valid for packages.
- CO** : Displays database backups (copies). Valid for databases, indexes, and tablespaces.
- COUNT** : Displays the number of rows in a table. Valid for tables.
- CR** : Generates SQL to create an object. Valid for aliases, databases, indexes, locations, logical units, storage groups, stored procedures, synonyms, tables, tablespaces, triggers, user-defined data types, and views.
- CRAL** : Generates SQL to create an alias. Valid for tables and views, and in the Modification Detail Display window.
- CRCT** : Allows you to create a Clone Table. Valid from the Table List display.
- CRHT** : Generates SQL to create a history table (table type=H) for the selected system-period temporal table. It displays the Edit Create HISTORY Table Information window. The generated SQL also includes the ADD VERSIONING USE HISTORY TABLE clause in the ALTER TABLE statement for the base temporal table. Valid from the Table display.
- CRIX** : Generates SQL to create an index. Valid for tables and in the Modification Detail Display window.
- CRMASK** : Generates SQL to create Column Mask objects. Valid in table column lists. Displays the Edit Create Column Mask outer and inner windows. In the inner window, define the case expression that describes to which column values users have access.
- CRMQ** : The CRMQ row command generates SQL to create a Materialized Query Table. Valid in table lists. To generate CREATE SQL from multiple tables, use the CRMQ primary command.
- CRPERM** : Generates SQL to create row permission objects. Valid in table lists. Display the Create Edit Row Permission outer and inner windows. In the inner window, define the search condition that describes to which rows users have access.
- CRSY** : Generates SQL to create a synonym. Valid for tables and views, and in the Modification Detail Display window.
- CRTB** : Generates SQL to create a table. Valid for tablespaces and in the Modification Detail Display window.
- CRTR** : Generates SQL to create a trigger. Valid for tables.
- CRTS** : Creates a tablespace in the current database. Valid for databases and in the Modification Detail Display window.
- CRVW** : Generates SQL to create a view. Valid for tables and in the Modification Detail Display window.
- CRXO** : Creates auxiliary objects for large objects. Valid for columns and tables.
- CT** : Displays either the Base Table for a Clone Table or the Clone Table for a Base Table. Valid from the Table List display.

- CTB** : Displays table details for child table. Valid for relationships (parent and child).
- DA** : Displays database authorizations. Valid for databases, distinct routine authorizations, distinct schema authorizations, and users.
- DATA** : Displays object data. Valid for tables and views.
- DB** : Displays databases with a specified object as a default. Valid for bufferpools, image copies, indexes, storage groups, tables, tablespaces, and users.
- DCL** : Generates declare statements (DCLGEN). Valid for tables and views. Also available as a primary command
- DDL** : Generates DDL CREATE statements for an object. Valid on impact reports, aliases, databases, indexes, storage groups, stored procedures, synonyms, tables, tablespaces, triggers, data types, and views.
- DEACT** : Generates SQL to deactivate row-level and/or column-level access control. It displays the Deactivate Row and or Column Access Control window. Valid from the Table display.
- DR** : Generates SQL to drop an object. Valid for aliases, databases, indexes, locations, logical units, packages, relationships, storage groups, stored procedures, synonyms, tables, tablespaces, triggers, user-defined data types, and views.
- DT** : Displays the user-defined data types for the selected object. Valid for columns, distinct schemas, and schema authorizations.
- EXCH** : Allows you to exchange Clone and Table data. Valid from the Table List display.
- FKY** : Displays related foreign keys. Valid for relationships and tables.
- FP** : Displays field PROCs. Valid for columns.
- FREE** : Supports the FREE DSN subcommand. Valid for packages and plans.
- GR** : Generates SQL to grant object privileges. Valid for bufferpools, collection IDs, columns, databases, distinct routine authorizations, distinct schema authorizations, distinct schemas, packages, plans, routine authorizations, schema authorizations, storage groups, stored procedures, tables, tablespaces, user-defined data types, users, and views.
- HT** : Displays the Base Table related to Clone Table window where the History (Versioning) Table that is related to the base Temporal Table is listed. Valid from the Table List display.
- ID** : Displays the identity column detail for a column. Valid for columns.
- IP** : Displays related index partitions. Valid for indexes, storage groups, and tablespace partitions.
- IPH** : Displays related index partition history. Valid for indexes, index history, and index partitions. Also available as a primary command.

- IX** : Displays related indexes. Valid for bufferpools, columns, databases, foreign keys, index partitions, packages, plans, storage groups, tables, tablespaces, and tablespace partitions.
- IXH** : Displays related index history. Valid for indexes and table history. Also available as a primary command.
- KT** : The KT row command displays the Key Targets window. It displays the rows from SYSKEYTARGETS which is populated when an expression is used to create the Index. Valid from the Index List and Columns of Index displays.
- LB** : Generates SQL to provide a label. Valid for aliases, columns, tables, and views.
- LK** : Displays limit key values for the selected table in a window. This command is valid for tables. Also available as a primary command.
- LOB** : Indented display of related auxiliary objects. Valid for tables.
- MA** : Displays the authorized users of schemas. Valid for distinct routine authorizations, distinct schema authorizations, distinct schemas, distinct users, schema authorizations, users, and user-defined data types.
- MASK** : Displays the defined column masks (access control rules) for the selected table. Valid in table lists.
- OA** : Displays authorized users of routines. Valid for distinct routine authorizations, distinct users, routine authorizations, and routines.
- PA** : Displays plan authorizations. Valid for distinct routine authorizations, distinct schema authorizations, plans and users.
- PD** : Displays plan dependencies. Valid for plans.
- PEND** : Displays the pending DDL information for databases, tablespaces, and indexes. Valid in database, tablespace, and index display lists.
- PERM** : Displays the defined row permissions (access control rules) for the selected table. Valid in table lists.
- PK** : Displays dependent packages. Valid for aliases, collection IDs, indexes, package users, plans, synonyms, tables, tablespaces, triggers, and views.
- PKA** : Displays package authorizations. Valid for distinct routine authorizations, distinct schema authorizations, package users and packages.
- PKD** : Displays package dependencies. Valid for packages.
- PKL** : Displays package lists. Valid for plans.
- PKRM** : Displays packages and DBRMs. Valid for plans.
- PKS** : Displays package systems. Valid for packages.
- PKY** : Displays primary key columns of the parent table. Valid for relationships and tables.
- PL** : Displays dependent plans or plans containing packages. Valid for aliases, indexes, packages, synonyms, tables, tablespaces, users, and views.
- PLCON** : Generates statements to convert DBRMs to packages. Valid for plans.

- PLS** : Displays plan systems. Valid for plans.
- PM** : Displays parameters. Valid for routines and stored procedures.
- PTB** : Displays table details for parent table. Valid for relationships (parent and child).
- QA** : The QA row command displays the authorized users for sequence objects. This command is valid for sequence objects.
- RA** : Displays resource authorizations. Valid for bufferpools, collection IDs, distinct routine authorizations, distinct schema authorizations, storage groups, tablespaces, user-defined data types, and users.
- RC** : Displays child relationships (single level). Valid for tables.
- REBIND** : Supports the REBIND DSN subcommand. Valid for packages and plans.
- REF** : Displays the Edit Refresh MQT window and generates a REFRESH TABLE statement for the selected Materialized Query Table (MQT) to update the data. Valid only for MQTs (table type 'M').
- RM** : Displays DBRMs. Valid for plans.
- RN** : Generates Rename Table, Column, or Index SQL command. Valid for tables, columns, and indexes.
- RO** : Displays routines. Valid for distinct schemas and routine authorizations.
- ROTATE** : Allows to rotate partitions for table-controlled partitioning tables. Rotating a partition allows a partition to be reused by a different set of data. The existing data in the partition is deleted and the partition is rolled to a new location for reuse. Valid in the Table Display and Tablespace Display windows. Only valid for partitioned objects.
- RP** : Displays parent relationships (single level). Valid for tables.
- RT** : Displays relationships (multilevel). Valid for tables.
- RTS** : Displays related real time statistics for a single object. Valid for databases, indexes, index partitions, tablespaces, and tablespace partitions.
- RV** : Generates SQL to revoke object privileges. Valid for bufferpools, collection IDs, databases, distinct routine authorizations, distinct schema authorizations, packages, plans, routine authorizations, schema authorizations, storage groups, tables, tablespaces, user-defined data types, users, and views.
- S** : (1) Displays associated tablespaces or indexes. Valid for VSAM datasets. (2) Supports the DB2 -DISPLAY command with the DETAIL(INTERVAL) LIST(ACTIVE) keywords. Valid for bufferpools. (3) Displays information on the source object in a compare. Valid for compare lists.
- SA** : Displays system authorizations. Valid for distinct routine authorizations and distinct schema authorizations.

- SG** : Displays storage group details. Valid for databases, indexes, index partitions, tables, tablespaces, tablespace partitions, and volumes. Also available as a primary command.
- SP** : Displays routines. Valid for schema authorizations.
- ST** : Displays statements. Valid for packages, plans, and DBRMs.
- STAT** : (1) Supports the DB2 -DISPLAY command with LSTATS parameter. Valid for bufferpools. (2) Displays related object statistics. Valid for columns, indexes, index partitions, tables, tablespace partitions, and tablespaces.
- STATH** : Displays statistics history. Valid for indexes, index partitions, tables, tablespace partitions, and tablespaces.
- STF** : Displays formatted statements. Valid for packages, plans, and DBRMs.
- SY** : Displays related synonyms. Valid for aliases, packages, plans, tables, and views.
- TA** : Displays table authorizations. Valid for distinct routine authorizations, distinct schema authorizations, packages, plans, tables, and users.
- TB** : Displays table details. Valid for aliases, columns, databases, indexes, packages, plans, storage groups, synonyms, tablespaces, users, and views.
- TBH** : Displays related table history. Valid for tables and index history. Also available as a primary command.
- TC** : Allows you to display trusted context for the role. Valid from the Roles display.
- TP** : Displays tablespace partitions. Valid for index partitions, storage groups, and tablespaces.
- TPH** : Displays related tablespace partition history. Valid for tablespaces and tablespace partitions. Also available as a primary command.
- TR** : Displays triggers. Valid for distinct schemas, schema authorizations, and tables.
- TRD** : Displays trigger dependents. Valid for triggers.
- TRUNC** : Generates SQL to TRUNCATE the table. Valid in table lists.
- TS** : Displays related tablespaces. Valid for bufferpools, databases, image copies, indexes, packages, plans, storage groups, tables, and tablespace partitions.
- TX** : Displays view text and long compare messages. Valid for triggers, views, and MQT.
- UC** : Displays unique constraints for a table. This command is valid for a table.
- VA** : Displays view authorizations. Valid for users and views.
- VD (View Dependency)** : Displays the View Dependency panel listing each dependency defined in SYSIBM.SYSVIEWDEP for the View. Valid from the View Display and Table Display windows.
- VL** : Displays related volumes. Valid for storage groups.

VW : Displays related views. Valid for aliases, columns, databases, packages, plans, synonyms, and tables.

VWB : Displays related base objects. Valid for views.

VWD : Displays related dependent objects. Valid for views.

XML : Displays the related XML objects for the table in an indented display. Valid for auxiliary relationships.

XMT : Displays the XML Tables Display window. Valid from the Owning Table for XML Table display.

XR : Displays the related XML object(s) for the table in the Owning Table for XML Table display. Valid for XML relationships.

XT : Displays the auxiliary table for a base table. Valid for auxiliary relationships. Also available as a primary command.

Edit

The edit row commands shown in Table 5 are valid in any window displaying data that can be edited.

Repeat Range

Follow the row command with the number (n) of executions. For example, use D5 to delete five rows.

Block Range

Duplicate the last letter of the command and enter it in the first and last rows of a block of rows. For example, enter CC in the first row to copy and CC in the last row to copy.

Table 5. Edit Row Commands

Command	Description	Repeat Range	Block Range
((shift left)	Shifts data left	<[n]	<<[n]
) (shift right)	Shifts data right	>[n]	>>[n]
A	Inserts rows after		
B	Inserts rows before		
C	Copies rows	C[n]	CC
COLS	Displays COLS row		
D	Deletes rows	D[n]	DD
HEX	Shows data in hexadecimal		
I	Inserts row with mask	I[n]	
IP	Inserts permanent row with mask	IP[n]	
LC	Translates to lowercase	LC[n]	LCC

Table 5. Edit Row Commands (Continued)

M	Moves rows	M[n]	MM
O	Overlays row	O[n]	OO
R	Repeats row	R[n]	RR
UC	Translates to uppercase	UC [n]	UCC
X	Excludes row	X[n]	XX

Guidelines for the Work Buffers

These guidelines help you efficiently use the work buffers.

- Whether or not the work buffer contains previously-generated statements depends on the CLEAR WORK BUFFERS setting in your profile. If this setting is YES, the window title will read “CLEAR” and the work buffer will be erased each time the window is ended. If it is set to NO, the window title will read “KEEP” and the contents will be saved in the work buffer.

Note: If the KEEP primary command was used in the work buffer, the contents will be kept regardless of the CLEAR WORK BUFFERS setting.

- The window that opens when the statements or commands are generated *shows the entire work buffer contents*. Your previously generated statements or commands, if any, may be shown at the top. *You may have to scroll the contents down to view newly generated statements or commands.*
- You can edit work buffer contents at any time before execution.
- After you execute the statements or commands, you would normally delete them from the buffer. The easy method is to use the CANCEL primary command or <Cancel> PF key on the work buffer window. The default <Cancel> key is PF15. When you <End> the window, the contents will automatically delete if the CLEAR WORK BUFFERS option in your profile is set to YES.
- If you don't delete the statements after executing them, you may accidentally re-execute them later. Make a habit of either deleting statements as they are executed, or always accumulating work buffer contents to be executed at one time.
- CANCEL does not remove previously saved statements—only those statements appended since the last commit point created with the SAVE command or the END command. To delete contents, use the D row command. For example, entering D+ on the first row deletes all statements. After deleting statements, press <End> to ensure an empty buffer for the next use.
- The CLEAR primary command deletes all rows in the work buffer.
- If you want to retain generated statements or commands in the work buffer, execute the KEEP primary command before ending the window. Or, make sure your CLEAR WORK BUFFERS profile option is set to No, and use one of the following:
 - END primary command.
 - <End> PF key. The default <End> key is PF3.

- Place the cursor on the bottom border of the window and press Enter for an implicit selection of an END command.
- Work buffer contents are erased when you terminate your File-AID session.
- Rows cannot be excluded from submission with the X (exclude) row command. To exclude a row, enter a double hyphen (--) in columns 1 and 2 or columns 2 and 3.
- All work buffers except the SQL work buffer are local mode only. You cannot execute buffer contents on another subsystem through system-directed access or application-directed access. This is true even if you have set a remote location with the LOCATION or CONNECT primary command. In the SQL work buffer, you can use the REMOTE command.
- You are always responsible for the accuracy of submitted or executed statements. You must review each statement carefully before submitting or executing.

Retrieving Work Buffer Contents

The contents of the work buffer can be retrieved in any of the following ways:

- Execute the SHOW primary command with the appropriate keyword:
 - SHOW JCL — displays the JCL work buffer
 - SHOW SQL — displays the SQL work buffer.

Once the work buffer is displayed, you can edit the contents and execute or submit the statements. Or, you can use the SAVE command to save the contents into a PDS.

