



File-AID/MVS

Reference Summary

Release 10.1

Please direct questions about File-AID/MVS,
hereafter called File-AID,
or comments on this document to:

Compuware Customer Support

<http://go.compuware.com>

This document and the product referenced in it are subject to the following legends:

Copyright 1982-2014 Compuware Corporation. All rights reserved. Unpublished rights reserved under the Copyright Laws of the United States.

U.S. GOVERNMENT RIGHTS-Use, duplication, or disclosure by the U.S. Government is subject to restrictions as set forth in Compuware Corporation license agreement and as provided in DFARS 227.7202-1(a) and 227.7202-3(a) (1995), DFARS 252.227-7013(c)(1)(ii) (OCT 1988), FAR 12.212(a) (1995), FAR 52.227-19, or FAR 52.227-14 (ALT III), as applicable. Compuware Corporation.

This product contains confidential information and trade secrets of Compuware Corporation. Use, disclosure, or reproduction is prohibited without the prior express written permission of Compuware Corporation. Access is limited to authorized users. Use of this product is subject to the terms and conditions of the user's License Agreement with Compuware Corporation.

File-AID, FrontLine, and Compuware are registered trademarks of Compuware Corporation.

IBM, MVS, z/OS, and RACF are trademarks or registered trademarks of International Business Machines Corporation.

Adobe® Reader® is a trademark of Adobe Systems Incorporated in the United States and/or other countries.

All other company and product names are trademarks or registered trademarks of their respective owners.

Contents

Introduction	1
Notation Rules	1
Reading the Syntax Diagrams	1
File-AID Options	3
Recursive Commands	6
Default PF Key Assignments	7
File-AID Dataset Requirements	8
Specifying a Dataset Name	8
Qualified Dataset Names	8
Unqualified Dataset Names	8
Pattern Dataset Names	9
Last Referenced File List	10
Pattern Member Names	10
Specifying a zFS Pathname	10
Catalog Names	11
File-AID Commands	11
JCL Specification Commands	11
Member List Processing Commands	12
Primary Command Availability Browse and Edit	13
Primary Command Availability Windowed Edit	16
Primary Commands	20
Line Commands	52
File-AID/Batch	53
Control Cards	53
Sample JCL Statements	54
Function/Parameter Compatibility	55
Functions	57
Function Modifiers	59
Parameters	60
Parameter Elements	72

Introduction

File-AID Reference Summary is an overview of File-AID's functions and summarizes information such as pattern name notation, primary and line commands, and batch parameters. For more information, refer to the *File-AID/MVS Online Reference* manual, or the *File-AID/MVS Batch Reference* manual and the product's online help.

Notation Rules

A parameter is either a keyword or a variable. All keywords are shown in UPPERCASE characters and must be spelled exactly as shown. You cannot substitute another value. All variables are user-specified values and are printed in *lowercase italics*. For example, *dataset-name* indicates you are to substitute a value.

Reading the Syntax Diagrams

Syntax boxes define primary command syntax.

- A **parameter** is either a keyword or a variable.
 - All KEYWORDS are shown in uppercase characters and must be spelled exactly as shown. You cannot substitute another value.
 - All *variables* are user-specified values and are printed in lowercase italics. For example, *dataset-name* indicates you are to substitute a value.

The syntax for commands is described in diagrams that help you visualize parameter use. The following example shows a command and a parameter:

▶▶—COMMAND——parameter▶▶

Read the diagrams from left to right and from top to bottom. These symbols help you follow the path of the syntax:

- ▶▶ indicates the beginning of a statement.
- indicates the statement is continued on the next line.
- ▶ indicates the statement is continued from the previous line.
- ▶▶ indicates the end of a statement.

Required parameters appear on the horizontal line (the main path):

▶▶—COMMAND——REQUIRED-KEYWORD——▶▶

Optional parameters appear below the main path. Default parameters that appear above the main path are optional; including or excluding them in the command has the same effect on the execution.

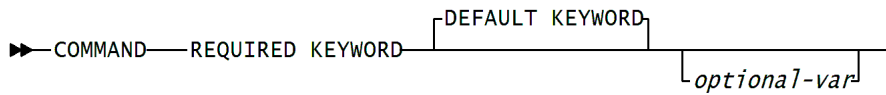

Vertically stacked parameters are mutually exclusive. If you must choose a parameter, one item of the stack appears on the main path. If the parameters are optional, the entire stack appears below the main path. If one of the parameters in a stack is the default, it appears above the main path:

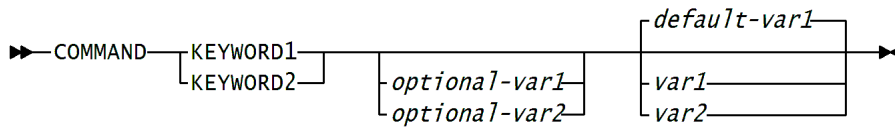

File-AID Options

This section lists the options available for each File-AID function and summarizes the parameters used with these functions. For detailed information, refer to the *File-AID/MVS Online Reference Manual*. File-AID uses the same selection values for its functions as ISPF/PDF.

0 — PARAMETERS

- 0.0 ISPF parameters and File-AID PF keys
- 0.1 File-AID system parameters
- 0.2 Selection criteria default parameters
- 0.3 Print default parameters
- 0.4 Processing option default parameters
- 0.5 Audit file allocation parameters
- 0.6 Hierarchical File System Options

1 — BROWSE

2 — EDIT

3 — UTILITIES

3.1 Library Utility

- A Map CSECTs in address order
- E Edit member of non-load library
- N Map CSECTs in name order
- I Display directory entry of member
- blank** Display member list
- B Browse member
- D Delete member
- R Rename member

3.2 Dataset Utility

- A Allocate SEQ/PDS dataset, including SMS dataset
- B Allocate BDAM dataset
- C Catalog dataset
- G Define generation data group
- D Delete dataset
- R Rename dataset
- U Uncatalog dataset

- F Free unused space
- S Dataset information (short)
- blank** Display dataset information

3.3 Copy Utility

3.4 Catalog Utility

- V Produce volume list of VSAM datasets
- blank** Generic catalog search

3.5 VSAM Utility

- A Allocate cluster
- S Allocate dataspace
- X Allocate alternate index
- B Build alternate index
- blank** Display dataset information
- D Delete dataset
- DR Delete/Define
- T Delete dataspace
- P Allocate path
- R Rename component
- M Modify component

3.6 Search/Update Utility

- M PDS Find/Change and member list processing
- B Browse using search criteria
- U Preview and update using search criteria

3.7 VTOC Utility

- I List volume information
- M Map VTOC entries in pack location sequence
- blank** List VTOC entries in dataset name sequence

3.8 Interactive Utility

Execute File-AID/Batch functions online. See "File-AID/Batch" on page 53.

3.9 Batch Submit Utility

Builds batch job streams for File-AID or other programs.

3.G XMLGEN

Generate an XML tagged document from data file.

5 — PRINT

- 5.1 Print the contents of a data file
- 5.2 Print the contents of a record layout XREF member
- 5.3 Print the contents of a selection criteria member
- 5.4 Print a record layout in formatted mode
- 5.5 Print the contents of an audit trail file

6 — SELECTION

7 — XREF

8 — VIEW

9 — REFORMAT

- blank** Create a new or change an existing reformat definition
- D** Dynamically create and execute a temporary reformat definition
- E** Execute a previously saved reformat definition

10 — COMPARE

Compare file contents.

- F** Formatted mode
- J** JCL mode
- L** Load Library mode
- S** Source Code mode
- U** Unformatted mode

C — CHANGES

Display a summary of File-AID changes.

T — TUTORIAL

Display information about File-AID.

X — EXIT

Terminate File-AID.

Recursive Commands

Online File-AID provides productivity commands that let you recursively invoke all File-AID functions. While in any File-AID screen, you can enter a recursive command on the COMMAND line. File-AID suspends the current display and immediately presents the requested function panel. When you exit the function panel, you are returned to the suspended display.

Table 1 summarizes the File-AID recursive commands. The optional *dataset-name* can be an unqualified dataset name without quotes, or a fully qualified dataset name with single quotes.

Table 1. Recursive Commands

Command	Description	Optional Parameter
BR, IB	Browse (ISPF/PDF)	
ED, IE	Edit (ISPF/PDF)	
F0	0 File-AID Parameters	
FB, F1	1 Browse	<i>dataset-name</i>
FE, F2	2 Edit	<i>dataset-name</i>
F3	3 Extended Utilities Menu	
F31	3.1 Library Utility	<i>dataset-name</i>
F32	3.2 Dataset Utility	<i>dataset-name</i>
F33	3.3 Copy Utility	<i>dataset-name</i>
F34	3.4 Catalog Utility	
F35	3.5 VSAM Utility	<i>dataset-name</i>
F36	3.6 Search/Update Utility	<i>dataset-name</i>
F37	3.7 VTOC Utility	
F38	3.8 Interactive Utility	<i>dataset-name</i>
F39	3.9 Batch Submit Utility	
F5	5 Print Menu	
F51	5.1 Print Data File	<i>dataset-name</i>
F52	5.2 Print Record/Layout XREF	
F53	5.3 Print Selection Criteria	
F54	5.4 Print Record Layout	
F55	5.5 Print Audit Trail	
F6	6 Selection	
F7	7 XREF	
F8	8 View	
F9	9 Reformat	
F10	10 Compare	<i>dataset-name</i>
FALISTA	LISTALC ALL Command	

Default PF Key Assignments

Key	Default Value	User-Assigned Value
PF1	HELP	
PF2	SPLIT	
PF3	END	
PF4	RETURN	
PF5	RFIND	
PF6	RCHANGE	
PF7	UP	
PF8	DOWN	
PF9	SWAP	
PF10	LEFT	
PF11	RIGHT	
PF12	RETRIEVE	
PF13	HELP	
PF14	SPLIT	
PF15	END	
PF16	RETURN	
PF17	RFIND	
PF18	RCHANGE	
PF19	UP	
PF20	DOWN	
PF21	SWAP	
PF22	LEFT	
PF23	RIGHT	
PF24	RETRIEVE	

File-AID Dataset Requirements

Dataset Type	DSORG	RECFM	LRECL
Record Layout*	Sequential, Partitioned, Panvalet, Librarian, GEM	*	*
XREF	Partitioned	VB	300
Selection Criteria	Partitioned	VB	300
Reformat Definition	Partitioned	VB	1570
Compare Criteria	Sequential or Partitioned	FB	80

* Must conform to the requirements for a valid Panvalet/Librarian file or a valid COBOL or PL/I copybook.

Specifying a Dataset Name

Enter the dataset name you want to process in the Dataset name field of a screen. A qualified dataset name is enclosed in single quotes (' '); an unqualified dataset name is not enclosed in single quotes. File-AID concatenates the TSO prefix to the front of an unqualified dataset name.

The Search name field in the Catalog utility (3.4) and VTOC utility (3.7) accept only qualified names entered without single quotes (' '). All other dataset name fields accept qualified (quoted) and unqualified (non-quoted) dataset names.

Qualified Dataset Names

A qualified dataset name is enclosed in single quotes (' '). The quotes specify that no other information is used as a prefix to the qualified name. Since the trailing quote is not required, a single leading quote can signify a qualified dataset name.

Unqualified Dataset Names

An unqualified dataset name is not enclosed in single quotes. The user prefix is concatenated to the beginning of the entered value.

Unqualified VSAM dataset names are prefixed with the installation-defined optional VSAM high-level name (described in the *File-AID Single Install Image Installation and Configuration Guide*). In addition, a user-defined VSAM intermediate name default can be set in the System Parameters (Option 0.1).

When a search fails for an unqualified dataset name, the VSAM name is constructed and the catalog is re-searched to see if the cluster can be located. For example, if **userprefix.DATASET.NAME** is not found, File-AID constructs the following dataset name for the cluster search:

```
vsam-high-level.vsam-intermediate-name.DATASET.NAME
```

Pattern Dataset Names

You can enter a pattern name in any Dataset name, Search name, Model dataset name, and Base cluster name field to produce a list of datasets that match the pattern. You can select a dataset from this list with the S (Select) line command.

The pattern dataset name is used most often as a dataset name prefix. This means that all datasets whose high-level qualifiers match the pattern are listed and there are no restrictions on the remaining qualifiers. See Figure 1.

When used, the / (slash) and + (plus) pattern characters limit the number of remaining qualifiers that are listed.

Figure 1. Pattern Dataset Name Prefix Example

```
Dataset name ==> 'USERID1.TEST.*'
```

In this example, File-AID lists all the datasets that have a first-level qualifier of USERID1, a second-level qualifier of TEST, and one or more subsequent qualifiers.

The first-level qualifier of the pattern dataset name must be an explicit qualifier with no pattern characters. If you leave the Search name field blank in File-AID's Catalog Utility (Option 3.4) Search name field, File-AID lists all datasets beginning with your user ID plus any VSAM clusters conforming to the default naming convention, as described in "Unqualified Dataset Names" on page 8.

File-AID's VTOC utility (Option 3.7) allows pattern characters at any level, including the first level, within the pattern dataset name for the Search name field.

Valid pattern characters for pattern dataset names include: * (asterisk), / (slash), + (plus), ? (question mark), and % (percent sign).

- The * (asterisk) pattern character is a qualifier-name wildcard. It represents any single-level qualifier, or partial-level qualifier when preceded by 1 to 7 explicit characters. When used as the last character it represents one or more remaining qualifiers.
- The ? (question mark) and the % (percent sign) pattern characters are both single-character wildcards. Either character represents a single character in the specified position of the qualifier. You can use a single-character qualifier up to 8 times within a qualifier, but a character must exist in that position.
- The / (slash) pattern character specifies the number of levels in the dataset name. Dataset names with more levels than those specified in the pattern dataset name are not listed. The / must be the last element in the pattern dataset name.
- The + (plus) pattern character tells File-AID to ignore any intermediate-level qualifiers. Use the + after the high-level qualifier and before the lowest-level qualifier to have File-AID ignore any intermediate qualifiers. In effect, it matches zero or more qualifiers in the name. In only the VTOC utility (3.7), the + (plus) may be used as the high-level qualifier in a search name.

- You can use only one + per name. The portion of the name before the + represents a pattern for the high-level qualifier(s) of the dataset name; the portion after the + represents a pattern for the low-level qualifier(s). When the + is used, only dataset names that begin and end exactly as the pattern does are displayed.
- You cannot use both the / and the + in the same pattern dataset name. The + implies a / at the end of the pattern dataset name.

Last Referenced File List

In Browse and Edit, the Last Referenced File List screen displays up to the last 50 files that you Browsed and/or Edited with File-AID. It is displayed when you enter the FILELIST primary command or blank out the “Dataset name or zFS path” field on the Browse or Edit Dataset Specification screen.

Primary commands enable you to sort by filename or referenced date and locate an entry by filename. Line commands allow you to select a file for processing, lock, unlock, and delete entries from the list, display the complete zFS path name, and display related dataset information. The related dataset information includes the Record Layout/XREF and Selection Criteria files that you associated with the referenced files.

Pattern Member Names

You can specify pattern characters in a Member name field to limit the members listed for selection. You cannot specify pattern characters in both the dataset name and member name fields at the same time. The * (asterisk), ? (question mark), and % (percent sign) are valid pattern characters for the member name field. The member name must be enclosed in parentheses (()) when entered in the Dataset name field.

The ? and the % function as single-character wildcards. An * can represent a partial or entire member name. It functions as a blank when used to represent the entire member name and produces a complete member list. When the asterisk is entered along with explicit characters, it functions as a single-character wildcard unless it is the last character in the pattern member name and then it matches any valid number of remaining characters.

Specifying a zFS Pathname

Enter the pathname of the file you want to process in the “Dataset name or zFS path” field. Enter the zFS pathname without quotes. When you are uncertain of the complete pathname or it is longer than the field, specify a partial pathname. File-AID displays the zFS Directory List screen which enables you to drill down and select the target file.

Use the following characters to indicate the pathname:

- / Begins with the root directory
- ./ Begins with the working directory
- ~ Begins with the home directory as defined on the z/OS UNIX File System Options screen (option 0.6).

If you specify a pathname for a zFS file that does not exist on the Edit Dataset Specification or Copy Dataset Specification screen (with a disposition of NEW), File-AID creates and opens the new zFS file with the following permissions:

- Read, Write and Search or Execute for the file owner
- Read and Search or Execute for the file group
- Read and Search or Execute for all others.

Catalog Names

You can specify a catalog dataset name on some File-AID screens. The specified value is always considered to be a qualified name, whether or not the name is enclosed within single quotes (' ').

File-AID Commands

This section summarizes the primary and line commands available in File-AID. For detailed information, refer to the *File-AID/MVS Online Reference Manual*.

JCL Specification Commands

When batch processing is specified for the online functions of Copy, VSAM, Search/Update, Print, Reformat, and Compare, File-AID displays the JCL Specification screen. It supports the following primary commands:

CANCEL : The CANCEL command cancels the function and returns to the original screen.

▶▶—CANCEL—◀◀

JCL : The JCL command displays the Generated JCL Edit screen with the Job Control Language that File-AID generates to process the function. This enables you to edit the JCL.

▶▶—JCL—◀◀

SUBMIT : The SUBMIT command submits the batch job.

▶▶ SUBMIT —▶▶
 └── SUB ───┘

Member List Processing Commands

Scrolling and the following primary commands are available on member selection lists:

CANCEL : The CANCEL command cancels current member selection and returns to the previous display.

▶▶ CANCEL —▶▶

LOCATE : The LOCATE command scrolls to the specified string.

▶▶ LOCATE — *string* —▶▶
 └── L ───┘

RESET : The RESET command reconstructs the current display with the entire member list, negating any processing or selection options, condense operations, and exclude line commands that have been specified.

▶▶ RESET —▶▶

SELECT : The SELECT command selects the specified member name for processing.

▶▶ SELECT — *member-name* —▶▶
 └── S ───┘

SORT : The SORT command sorts the member list. Any column header on the member list display is a valid keyword parameter for SORT. In the Library utility, the SORT command is valid for non-load libraries.

▶▶ SORT —▶▶

NAME
VV
CRE
CHA
SIZE
INIT
MOD
ID

Table 2. Primary Command Availability (Continued)

Command	(1) Character Browse	(1) Formatted Browse	(1) Vertical Formatted Browse	(1) Unformatted Browse	(2) Character Edit	(2) Formatted Edit	(2) Vertical Formatted Edit	(2) Unformatted Edit	(6) Formatted Selection Criteria	(7) Formatted XREFs
GO	X	X	X	X	X	X	X	X		
GROUP		X				X			X	X
HEX	X		X	X	X		X	X		
HIDE		X	X			X	X			
HOLD		X	X			X	X			
INFO	X		X		X		X			
INIT						X				
INPUT						X		X	X	X
INSERT						X		X	X	X
INVALIDCHAR			X				X			
KEY	X	X	X	X	X	X	X	X		
LEFT	X	X	X	X	X	X	X	X	X	X
LEVEL					X					
LISTALC	X	X	X	X	X	X	X	X		
LOCATE	X	X	X	X	X	X	X	X	X	X
LR		X				X		X	X	X
MAP	X		X	X	X		X	X		
MERGE					X		X			
MESSAGE	X	X	X	X	X	X	X	X	X	X
NEXT		X				X				
OCCURS		X				X			X	X
OFFSET		X	X			X	X		X	X
OPT									X	
OVERLAY					X		X			
PAD					X		X			
PASTE					X		X			
PICTURE		X				X				
PRESERVE					X	X	X	X		
PREV		X				X				
PROFILE	X	X	X		X	X	X		X	X
PROTECT		X				X				
RBA*	X	X	X	X	X	X	X	X		
RCHANGE					X	X	X	X		
REBUILD						X				
RECORD									X	
REDEFINES		X	X			X	X		X	X
REFLNG		X				X			X	X
REMOVE						X				
REPEAT						X		X	X	X
REPLACE					X		X			

Table 2. Primary Command Availability (Continued)

Command	(1) Character Browse	(1) Formatted Browse	(1) Vertical Formatted Browse	(1) Unformatted Browse	(2) Character Edit	(2) Formatted Edit	(2) Vertical Formatted Edit	(2) Unformatted Edit	(6) Formatted Selection Criteria	(7) Formatted XREFs
RESET	X	X	X	X	X	X	X	X	X	X
RETURN	X	X	X	X	X	X	X	X	X	X
RFIND	X	X	X	X	X	X	X	X		
RIGHT	X	X	X	X	X	X	X	X	X	X
RLOC		X	X			X	X			
SAVE					X	X	X	X	X	
SELECT									X	
SETUNDO					X	X	X	X		
SHOW		X	X			X	X		X	X
SORT	X	X	X	X	X	X	X	X		
STATS					X					
SUBMIT	X				X					
SYNC		X				X			X	X
TOP		X				X			X	
UNDO					X	X	X	X		
UNFMT	X	X	X		X	X	X		X	
UP	X	X	X	X	X	X	X	X	X	X
USE		X	X			X	X		X	X
VERSION					X					
VFMT	X	X		X	X	X		X		
VIEW									X	X
VPRINT			X				X			
XMLGEN		X				X				
ZERO		X	X			X	X		X	X

* Valid only for ESDS files.

Primary Command Availability Windowed Edit

Table 3 and Table 4 on page 18 show primary command availability for each display mode of the Windowed Edit functions (Character, Formatted, Vertical Formatted, and Unformatted). In Windowed Browse, all standard Browse commands are available except for EXCLUDE, SORT, and SUBMIT.

Table 3. Windowed Edit Primary Command Availability - VSAM / IAM Files

Command	Character	Formatted	Vertical Formatted	Unformatted
ADD		X		
ALIGN		X		
ARRAY		X		
AUTOSAVE	X	X	X	X
BACK	X	X	X	X
BOUNDS	X		X	
CANCEL	X	X	X	X
CAPS	X	X	X	X
CHANGE	X	X	X	X
CHAR		X	X	X
COMPILE	X			X
COMPLEX		X		
DELETE		X		X
DISPLAY		X	X	
DISPLAY REDEF		X	X	
DOWN	X	X	X	X
END	X	X	X	X
FBROWSE	X	X	X	X
FEDIT	X	X	X	X
FILLER		X	X	
FIND	X	X	X	X
FMT	X		X	X
FORWARD	X	X	X	X
FPRINT		X		
GROUP		X		
HEX	X		X	X
INFO	X		X	
INIT				
INPUT		X		X

Table 3. Windowed Edit Primary Command Availability - VSAM / IAM Files (Continued)

Command	Character	Formatted	Vertical Formatted	Un-formatted
INSERT		X		X
INVALIDCHAR			X	
KEY	X	X	X	X
LEFT	X	X	X	X
LISTALC	X	X	X	X
LOCATE	X	X	X	X
LR		X		
MAP	X		X	X
MESSAGE		X		X
NEXT		X		
OCCURS		X		
OFFSET		X	X	
OVERLAY				
PICTURE		X	X	
PRESERVE	X	X	X	X
PREV		X		
PROFILE	X	X	X	
RCHANGE	X	X	X	X
REDEFINES		X	X	
REFLNG		X		
REMOVE		X		
REPEAT		X		X
REPLACE				
RESET	X	X	X	X
RETURN	X	X	X	X
RFIND	X	X	X	X
RIGHT	X	X	X	X
RLOC		X	X	X
SAVE	X	X	X	X
SHOW		X	X	
SYNC		X		
TOP		X		
UNDO	X	X	X	X
UNFMT	X	X	X	

Table 3. Windowed Edit Primary Command Availability - VSAM / IAM Files (Continued)

Command	Character	Formatted	Vertical Formatted	Un-formatted
UP	X	X	X	X
USE		X	X	
VFMT	X	X		X
VPRINT			X	
ZERO		X	X	

Table 4. Windowed Edit Primary Command Availability - Sequential Files

Command	Character	Formatted	Vertical Formatted	Un-formatted
ADD				
ALIGN		X		
ARRAY		X		
AUTOSAVE	X	X	X	X
BACK	X	X	X	X
BOUNDS	X		X	
CANCEL	X	X	X	X
CAPS	X	X	X	X
CHANGE	X	X	X	X
CHAR		X	X	X
COMPILE	X			X
COMPLEX		X		
DELETE				
DISPLAY		X	X	
DISPLAY REDEF		X	X	
DOWN	X	X	X	X
END	X	X	X	X
FBROWSE	X	X	X	X
FEDIT	X	X	X	X
FILLER		X	X	
FIND	X	X	X	X
FMT	X		X	X

Table 4. Windowed Edit Primary Command Availability - Sequential Files (Continued)

Command	Character	Formatted	Vertical Formatted	Un-formatted
FORWARD	X	X	X	X
FPRINT		X		
GROUP		X		
HEX	X		X	X
INFO	X		X	
INIT				
INPUT				
INSERT				
INVALIDCHAR			X	
KEY				
LEFT	X	X	X	X
LISTALC	X	X	X	X
LOCATE	X	X	X	X
LR		X		
MAP	X		X	X
MESSAGE		X		X
NEXT		X		
OCCURS		X		
OFFSET		X	X	
OVERLAY				
PICTURE		X	X	
PRESERVE	X	X	X	
PREV		X		
PROFILE	X	X	X	
RBA*	X	X	X	X
RCHANGE	X	X	X	X
REDEFINES		X	X	
REFLNG		X		
REMOVE				
REPEAT				
REPLACE				
RESET	X	X	X	X
RETURN	X	X	X	X
RFIND	X	X	X	X

Table 4. Windowed Edit Primary Command Availability - Sequential Files (Continued)

Command	Character	Formatted	Vertical Formatted	Un-formatted
RIGHT	X	X	X	X
RLOC		X	X	
SAVE	X	X	X	X
SHOW		X	X	
SYNC		X		
TOP		X		
UNDO	X	X	X	X
UNFMT	X	X	X	
UP	X	X	X	X
USE		X	X	
VFMT	X	X		X
VPRINT			X	
ZERO		X	X	

* Valid only for ESDS files.

Primary Commands

Primary commands are entered in the COMMAND field.

ADD : Inserts segment into a variable-length record.

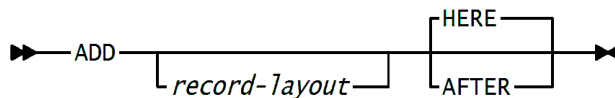

record-layout : Specifies the record layout used in formatting the new segment.

HERE : Specifies that the new segment is to be inserted prior to the currently displayed segment.

AFTER : Specifies that the new segment is to be inserted after the current segment.

ALIGN : Controls display of ALIGNED/UNALIGNED term for PL/I data.

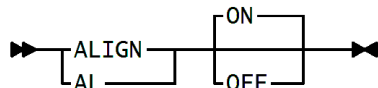

ARRAY : Controls display of array declaration information for PL/I data.

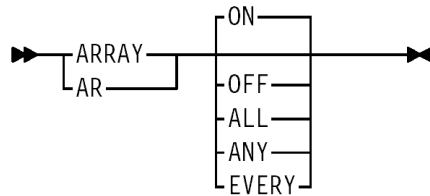

ON : Displays an array definition line for each subscripted item in a record layout.

OFF : Does not display an array definition line.

Selection Criteria Functionality

ANY, EVERY and ALL are only available in Formatted Selection Criteria.

ALL : Displays all occurrences separately with the subscript(s) and any criteria entered on a specific occurrence will only be applied to that occurrence.

ANY : Displays a single entry for the occurrences and any criteria entered for the ANY occurrence will be applied to all occurrences. The record will meet the Selection Criteria if **any** of the occurrences meet the specified criteria. ANY is applied for initial display of Selection Criteria.

EVERY : Displays a single entry for the occurrences and any criteria entered for the EVERY occurrence will be applied to all occurrences. The record will meet the Selection Criteria if **all** of the occurrences meet the specified criteria.

AUTOSAVE : Controls whether a modified dataset is saved when the user exits.

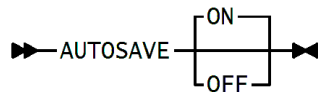

BACK : Scrolls display to the previous record in formatted mode. Scrolls the display up in character or vertical formatted mode.

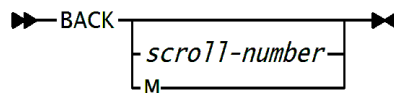

scroll-number : Number of records to scroll back. Attempts to scroll before the first (selected) record are treated as a maximum scroll.

M (maximum) : Scrolls the display to the first (selected) record of the file.

BOUNDS : Restricts the scope of a command to a specified range of columns.

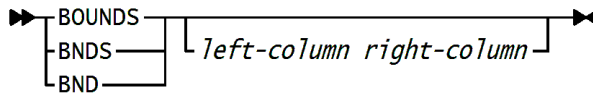

left-column, right-column : Specifies valid left and right column numbers separated by a blank that sets the left and right bounds (endpoints) of editing. Subsequent editing commands are restricted to the specified range of columns including both bounds.

CANCEL : Exits from current display mode and ignores all changes made to the dataset since the last **SAVE** command.

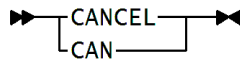

CAPS : Controls handling of entered characters as upper or mixed (upper and lower) case.

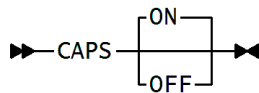

CHANGE : Changes data that meets specified conditions. When you enter the **CHANGE** command without parameters, File-AID displays the **CHANGE** Command screen. The screen field names are shown in parentheses next to their corresponding parameter terms.

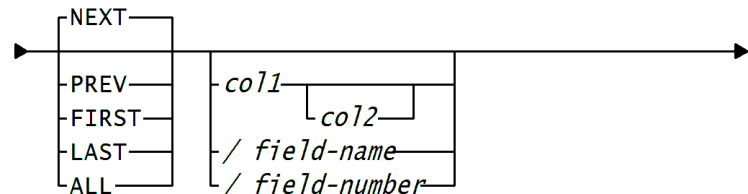
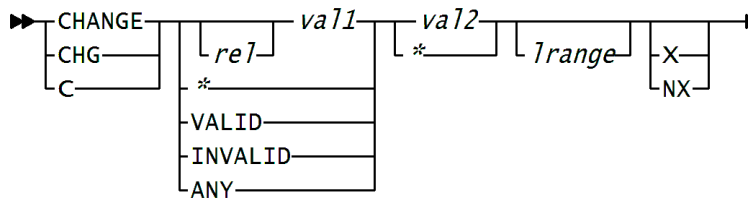

rel (**Operator**) : Relational operator that specifies the relationship the edit data must have to the *val1* parameter in order to be changed. Valid entries for this parameter are:

EQ: Matches any string equal to *val1* (default)

NE: Matches any string not equal to *val1*

LT: Matches any string less than *val1*

GT: Matches any string greater than *val1*

LE: Matches any string less than or equal to *val1*

GE: Matches any string greater than or equal to *val1*.

The *rel* parameter can be used with a *val1* parameter (or a substitute asterisk), but not with the parameters VALID, INVALID, or ANY. When *val1* is a character string, the comparison is executed according to the EBCDIC collating sequence.

***val1* (From string) :** Provides a value to be matched using the comparison specified by the *rel* parameter. When used with a */field-name* or */field-number* parameter, *val1* is required to be compatible with the field declaration in the record layout.

File-AID does not perform any case conversion for DBCS (double byte character set) data.

The *val1* parameter may be any one of the following data type strings:

Data type:	Example:
Simple	ABC
Delimited	'AB CD'
Character	C'Smith'
Hexadecimal	X'F1F2F3'
Decimal	999
Packed	P'59'
Packed data	PL4
Text	T'AnyCASE'

*** (asterisk) :** Enter an asterisk (*) in place of the *val1* parameter to reuse the last value specified in a CHANGE, EXCLUDE, or FIND command.

VALID, INVALID : Changes valid or invalid data in a specified field.

A */field-name* or */field-number* parameter is required when one of these values is used.

ANY : Changes any value in a range of columns by specifying *col-1*, and optionally, *col-2*. Also changes any value in a field by using a specific field name.

***val2* (To string) :** Specifies the new value to be substituted for data matching the condition specified by the *rel* and *val1* parameters. Data item length described by *val2* and *val1* must be the same.

*** (asterisk) :** Value for the *val2* parameter that specifies File-AID to reuse the last value entered in a CHANGE command.

***lrange* (Start range, End range) :** Confines the CHANGE command to a specified line range (records). For the line range limits, use any combination of user-defined labels, system labels, or line numbers prefixed by a period.

If a single line label or line number is specified (or the same line is specified twice), File-AID limits the search to the specified line.

X, NX (Lines to search) : X restricts the CHANGE command to excluded lines; NX restricts the CHANGE command to non excluded lines.

NEXT, PREV, FIRST, LAST, ALL (Modifier) : Use the NEXT, PREV, FIRST, or LAST values to specify the starting point and search direction.

Use the ALL parameter to process all lines (selected by rel and val1) that contain the specified data (within the lines defined by the lrange, X, and NX parameters).

col1, col2 (Start column, End column) : Specifies a valid single column (col1) or column range (col1 and col2). File-AID defaults to the current bounds settings if col1 and col2 are not specified. Specify a single column or column range to override the default column range. Data specified for a single column must begin at the col1 position. Data specified for a column range must be found within the specified range.

Note: The col2 parameter must follow the col1 parameter.

Specify the col1 and col2 parameters as integers. If the val1 or val2 parameters consist of the numbers 0 (zero) through 9, delimit the value of the val1 and/or val2 parameter to distinguish it from column numbers. Do not use col1 or col2 when the /field-name or /field-number parameter is used.

/field-name, /field-number (Field name, Field number) : The /field-name parameter specifies the data name given to the field in the record layout. The /field-number parameter specifies the number generated by File-AID for each data name in the record layout. If a name was specified in the record layout dataset or XREF dataset name fields on the Edit - Dataset Specification screen, you can use a /field-name or /field-number parameter to confine the search to a specific data field.

CHANGE (CHG or C) : Displays the Data Replace Criteria panel. Only valid on the Global Selection Criteria panel.

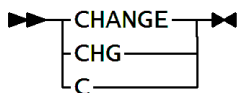

CHAR : Invokes character mode from formatted, vertical formatted, and unformatted modes of Browse and Edit.



COLS : Displays COLS information line to view column numbers.

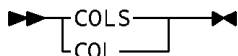

COMPILE : Displays the Record Layout Specification screen which allows you to reload or switch a record layout or XREF.

▶▶—COMPILE—◀◀

COMPLEX : Controls display of COMPLEX term for PL/I data.

▶▶—COMPLEX—
 —CMLX—
 —ON—
 —OFF—
 ▶◀

COPY : Inserts records from another file at a specified location.

▶▶—COPY—
 —*dataset*—
 —*dataset (member)*—
 —(*member*)—
 —AFTER—*line-label*—
 —BEFORE—*line-label*—
 ▶◀

dataset, member : Specifies the entire dataset or a member to be copied.

If you omit the *dataset* parameter, the Edit COPY screen is displayed.

AFTER *line-label*, BEFORE *line-label* : Designates the destination. The *line-label* parameter must be specified as a sequence number (prefixed by a period), a system label (such as .ZFIRST, .ZLAST, or .ZCSR), or a user-defined label.

The A (after), B (before), H (here), or O (overlay) line commands can be used as an alternative to a label to specify the destination. You can specify multiple A (after), B (before), and H (here) line commands. If you do not specify a destination, File-AID displays the message: **COPY IS PENDING**.

CREATE : Creates a new member of a PDS. Specify source records with the C or M line command.

▶▶—CREATE—
 —CRE—
 —*dataset (member)*—
 —(*member*)—
 ▶◀

dataset(member) : To create a new member in a different PDS, specify the dataset name followed by the member name enclosed in parentheses.

(*member*) : Specifies the name of a new member to be created in the same PDS as the member currently being edited.

CUT : Creates a temporary copy of a file (or portion of a file) that you are editing with File-AID/MVS Edit. Use the C or CC (copy) line command to specify the source of the 'cut'.

▶▶—CUT—
 —APPEND—
 ▶◀

APPEND (A) : Use the A or APPEND parameter to add to the existing cut file.

DELETE : Deletes records or lines from the dataset.

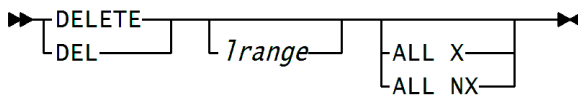

range : Optionally confines the scope of the DELETE command to the specified line range. A line range may be specified with one or two line labels. Use user-defined line labels, system-defined labels (.ZFIRST, .ZLAST, or .ZCSR), or line numbers in any combination preceded by a period (.).

ALL X : Causes all excluded lines within the specified line range to be deleted.

ALL NX : Causes all non excluded lines within the specified line range (or the entire dataset) to be deleted.

DISPLAY : Specifies fields for display or a display format.

Field Selection Syntax:

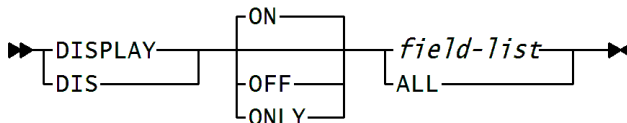

ON, OFF, ONLY : Controls the display of specified fields as follows:

ON: Displays fields specified by the *field-list* parameter along with the fields that are already displayed.

OFF: Prohibits display of fields specified by the field-list parameter.

ONLY: Displays only the specified fields.

When formatted or vertical formatted modes are invoked, File-AID displays all fields defined in the record layout. To eliminate fields from the display, enter either **DISPLAY OFF** or **DISPLAY ONLY**.

field-list : Specifies any combination of field numbers and/or field number ranges. Field numbers are separated by either blanks or commas.

Field number ranges are specified by two field numbers separated by a dash (-), and represent the two range bounds and all intervening fields.

ALL : Selects every field in the record. Enter **DISPLAY ALL** to display all fields. Enter **DISPLAY OFF ALL** to eliminate all fields from the display. The ALL parameter is mutually exclusive with the field-list parameter.

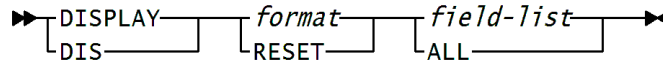
Data Format Specification Syntax:

format : Specifies the format of the data to be displayed. Valid values, results, and any field size limitations are listed below. Abbreviations of the values are shown in parentheses.

BINARY or **(BIN)**: Causes File-AID to interpret the data field as a binary number and display the integer (base 10) value of the binary number. Limited to 1, 2, 3, or 4 bytes.

BIT: Displays the actual bit pattern.

CHAR or **DISPLAY (AN, DISP)**: Displays data as alphanumeric characters. Invalid characters are displayed in hexadecimal format.

DECIMAL (DEC): Interprets data as packed decimal data. Limited to 1-16 bytes.

FLOAT: Interprets the data field as a decimal floating point number. Limited to 4, 8, or 16 bytes.

GRAPHIC: Displays data as DBCS characters. Invalid characters are displayed in hexadecimal format.

HEX (X): Displays data in hexadecimal format.

NATIONAL or **UT16**: Interprets data as Unicode UTF-16 and converts it to EBCDIC via IBM conversion services with the terminal CCSID. When conversion fails, original data are displayed in hexadecimal format. Limited to even bytes.

For any format value other than BIT, data items must be aligned on a byte boundary. If the format value is incompatible with any of the listed fields, any incompatible fields retain their prior formats.

The format parameter is mutually exclusive with the RESET parameter.

RESET (RES) : Restores the display of each listed field to the format specified by the record layout. The RESET parameter is mutually exclusive with the format parameter.

field-list : Specifies any combination of field numbers and/or field number ranges. Field numbers are separated by either blanks or commas.

Field number ranges are specified by two field numbers separated by a dash (-), and represent the two range bounds and all intervening fields.

ALL : Selects every field in the current layout. Enter **DISPLAY format ALL** to set the format of all fields to the specified format.

DISPLAY MAXREFER (DIS MAXREFER) : The DISPLAY MAXREFER command is used with a PL/1 layout that has a REFER clause. It allows you to specify the number of occurrences to display in the layout.

The command is available in the Formatted Selection Criteria screen.

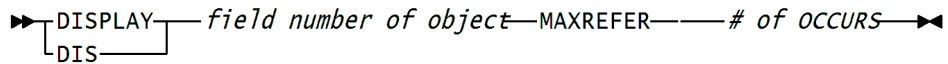

field-number of object : Specifies the object of a PL/1 REFER clause.

#- of OCCURS : Specifies the number of occurrences to be displayed.

DISPLAY REDEF : Selects COBOL redefinition of a data item for display.

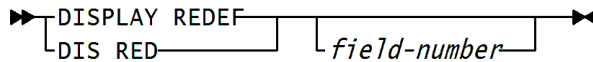

field-number : Specifies the COBOL data item redefinition to be displayed. Usually refers to a field that contains a REDEFINES clause, or is redefined by another field.

DOWN : Scrolls the display down. Default is the value in the SCROLL field. Scroll values include CSR, DATA, HALF, and PAGE.

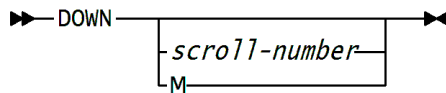

scroll-number : Specifies the number of lines or fields to scroll down.

M : Scrolls down the maximum amount. The effect of this parameter varies by mode:

- **Character and Vertical Formatted:** Scrolls down to show the last lines of the dataset.
- **Formatted:** Scrolls down to display the last fields of the record layout.

END : Exits the current browse, edit, or selection criteria session.



EXCLUDE : Removes from display items that meet specified conditions. When you enter the EXCLUDE command without parameters, File-AID displays the

EXCLUDE Command screen. The screen field names are shown in parentheses next to their corresponding parameter terms.

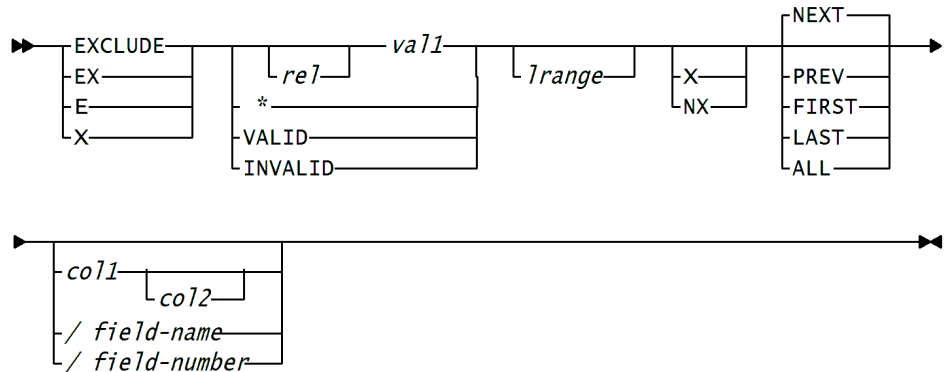

rel (Operator) : Relational operator that specifies the relationship the edit data must have to the *val1* parameter in order to qualify a line for exclusion. Valid entries for this parameter are:

EQ: Matches any string equal to *val1* (default)

NE: Matches any string not equal to *val1*

LT: Matches any string less than *val1*

GT: Matches any string greater than *val1*

LE: Matches any string less than or equal to *val1*

GE: Matches any string greater than or equal to *val1*.

The *rel* parameter may be used with a *val1* parameter (or a substitute asterisk), but not with the parameters VALID and INVALID. When *val1* is a character string, the comparison is executed according to the EBCDIC collating sequence.

val1 (Find string) : Provides a value to be matched using the comparison specified by the *rel* parameter. When used with a */field-name* or */field-number* parameter, *val1* is required to be compatible with the field declaration in the record layout.

File-AID does not perform any case conversion for DBCS (double byte character set) data.

The *val1* parameter may be any one of the following data type strings:

Data type:	Example:
Simple	ABC
Delimited	'AB CD'
Character	C'Smith'
Hexadecimal	X'F1F2F3'
Decimal	999
Packed	P'59'

Data type:	Example:
Packed data	PL4
Text	T'AnyCASE'

*** (asterisk)** : Value for the *val1* parameter that specifies to reuse the last value specified in a CHANGE, EXCLUDE, or FIND command.

VALID, INVALID : Excludes valid or invalid data in a specified field. A */field-name* or */field-number* parameter is required when VALID or INVALID is used.

***lrange* (Start range, End range)** : Confines the EXCLUDE command to a specified line range (records). For the line range limits, use any combination of user-defined labels, system labels, or valid line numbers, prefixed by a period.

If a single line label or line number is specified (or the same line is specified twice), File-AID limits the search to the specified line.

X, NX (Lines to search) : X restricts the EXCLUDE command to excluded lines. NX restricts the EXCLUDE command to non excluded lines.

NEXT, PREV, FIRST, LAST, ALL (Modifier) : Use the NEXT, PREV, FIRST, or LAST values to specify the starting point and search direction.

Use the ALL parameter to exclude all lines that contain the specified data (within the lines defined by the *lrange* and X, NX parameters).

***col1, col2* (Start column, End column)** : Specifies a valid single column (*col1*) or column range (*col1* and *col2*). File-AID defaults to the current bounds settings if *col1* and *col2* are not specified.

Specify a single column or column range to override the default column range. Data specified for a single column must begin at the *col1* position. Data specified for a column range must be found within the specified range.

Note: The *col2* parameter must follow the *col1* parameter.

Specify the *col1* and *col2* parameters as integers. If the *val1* parameter consists of the numbers 0 (zero) through 9, delimit the value of the *val1* parameter to distinguish it from the column values.

***/field-name, /field-number* (Field name, Field number)** : The */field-name* parameter specifies the data name given to the field in the record layout. The */field-number* parameter specifies the number generated by File-AID for each data name in the record layout. If a name was specified in the record layout dataset or XREF dataset name fields on the Edit - Dataset Specification screen, you can use a */field-name* or */field-number* parameter to confine the search to a specific data field.

If a record layout was not entered on the Edit screen, attempting to specify a */field-name* or */field-number* produces the message: FIELD UNDEFINED - NO LAYOUT.

FBROWSE : Recursively invokes the File-AID Browse function.

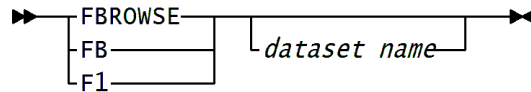

dataset name : Qualified (quoted) or unqualified (no quotes) dataset name to pass to the Browse screen. If no dataset name is specified, the last dataset referenced in File-AID is used as a default.

FEDIT : Recursively invokes the File-AID Edit function.

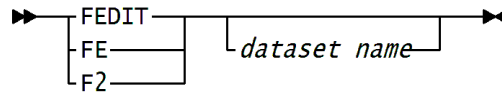

dataset name : Qualified (quoted) or unqualified (no quotes) dataset name to pass to the Edit - Dataset Specification screen. If a dataset name is not specified, File-AID uses the last dataset referenced.

FILLER : Controls display of FILLER fields.

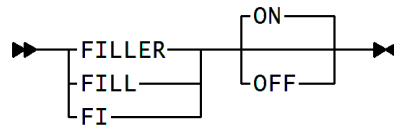

FIND : Searches for and displays items that meet specified conditions. When you enter the FIND command without parameters, File-AID displays the FIND Command screen. The screen field names are shown in parentheses next to their corresponding parameter terms.

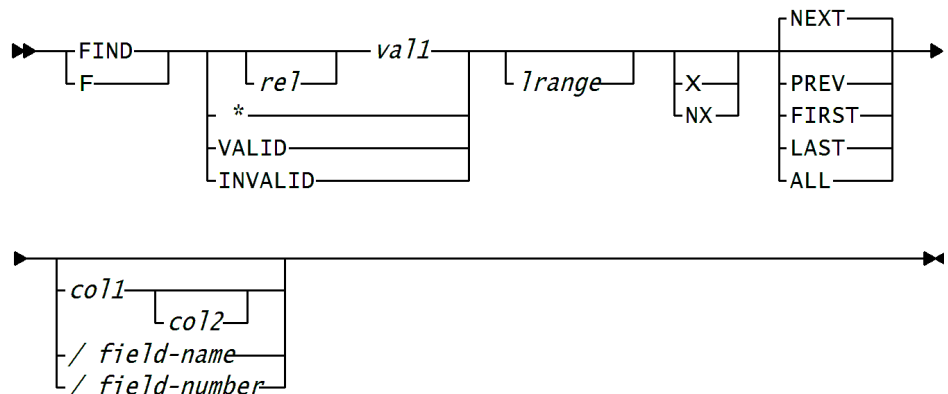

rel (Operator) : Relational operator that specifies the relationship the data must have to the *val1* parameter in order to be found. Valid entries for this parameter are:

EQ: Matches any string equal to *val1* (default)

NE: Matches any string not equal to *val1*

LT: Matches any string less than *val1*

GT: Matches any string greater than *val1*

LE: Matches any string less than or equal to *val1*

GE: Matches any string greater than or equal to *val1*.

The *rel* parameter may be used with a *val1* parameter (or a substitute asterisk), but not with the parameters VALID and INVALID. When *val1* is a character string, the comparison is executed according to the EBCDIC collating sequence.

***val1* (Find string) :** Provides a value to be matched using the comparison specified by the *rel* parameter. When used with a */field-name* or */field-number* parameter, *val1* is required to be compatible with the field declaration in the record layout.

File-AID does not perform any case conversion for DBCS (double byte character set) data.

The *val1* parameter may be any one of the following data types:

Data type:	Example:
Simple	ABC
Delimited	'AB CD'
Character	C'Smith'
Hexadecimal	X'F1F2F3'
Decimal	999
Packed	P'59'
Packed data	PL4
Text	T'AnyCASE'

*** (asterisk) :** Value for the *val1* parameter that specifies File-AID to reuse the last value specified in a CHANGE, EXCLUDE, or FIND command.

VALID, INVALID : Searches for valid or invalid data in a specified field.

A */field-name* or */field-number* parameter is required when VALID or INVALID is used.

***lrange* (Start range, End range) :** Confines the FIND command to a specified range of lines (records). For the line range limits, use any combination of user-defined labels, system labels, or line numbers, prefixed by a period.

If a single line label or line number is specified (or the same line is specified twice), the search is confined to the specified line.

X, NX (Lines to search) : X restricts the FIND command to excluded lines. NX restricts the FIND command to non excluded lines.

NEXT, PREV, FIRST, LAST, ALL (Modifier) : Use the NEXT, PREV, FIRST, or LAST values to specify the starting point and search direction.

The ALL value searches for all occurrences of the specified data (within the lines defined by the lrange, X, and NX parameters).

col1, col2 (Start column, End column) : Specifies a valid single column (*col1*) or column range (*col1* and *col2*). File-AID defaults to the current bounds settings if *col1* and *col2* are not specified. To override the default, specify either a single column or column range. Data specified for a single column must begin at the *col1* position. Data specified for a column range must be found within the specified range.

Note: The *col2* parameter must follow the *col1* parameter.

Specify the *col1* and *col2* parameters as integers. If the *val1* parameter consists of the numbers 0 (zero) through 9, delimit the value of the *val1* parameter to distinguish it from the column values. Do not use *col1* or *col2* when the */field-name* or */field-number* parameter is used.

/field-name, /field-number (Field name, Field number) : The */field-name* parameter specifies the data name given to the field in the record layout. The */field-number* parameter specifies the number generated by File-AID for each data name in the record layout. If a name was specified in the record layout dataset or XREF dataset name fields on the Edit - Dataset Specification screen, you can use a */field-name* or */field-number* parameter to confine the search to a specific data field.

FLIP : Reverses the exclude status of all the records in the file.

▶—FLIP—◀

FMT : Invokes formatted mode from character, vertical formatted, and unformatted modes of Browse and Edit.

▶—FMT—◀

In Selection Criteria (Option 6), FMT displays the Formatted Selection Criteria screen.

▶—FMT—◀
 |
 |—F—
 |
 |—2—
 |

FORWARD : Scrolls the display to the next record in formatted mode. Scrolls the display down in character or vertical formatted mode.

▶—FORWARD—◀
 |
 |—FWD—
 |
 |—scroll-number—
 |
 |—M—

scroll-number : Number of records to scroll forward. Attempts to scroll past the last (selected) record are treated as a maximum scroll.

M (maximum) : Scrolls the display to the last (selected) record of the file.

FPRINT : Prints one or more records in formatted mode, presenting the data according to a COBOL or PL/I record layout. Use the DISPLAY primary command to tailor the current display of fields.

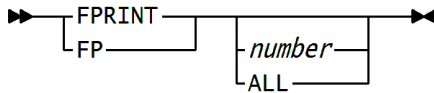

number : Specifies the number of records to print. The default is 1 (one). 0 (zero) prints the current and all subsequent records in the file.

ALL : Prints the current record and all subsequent records in the file.

GLOBAL (GBL) : Displays the GLOBAL Selection Criteria panel listing all defined variables. Only valid on the formatted Selection Criteria panel.

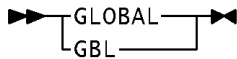

GO : The GO command switches your session into Browse (from Edit) or Edit (from Browse) while retaining your current record and cursor position. However, when using the GO command in a segmented record while positioned in a segment, the record will be re-positioned to the BASE.

Note: When browsing a VSAM LDS with Selection Criteria, the GO command is not available as Selection Criteria is not supported for VSAM LDS in Edit.

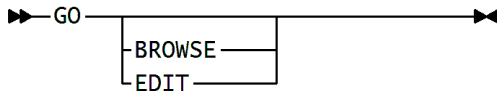

BROWSE : Switches your session into Browse (from Edit).

EDIT : Switches your session into Edit (from Browse).

GROUP : Controls the display of occurrences of group-level items.

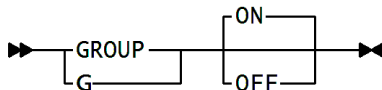

HEX : Changes data display to hexadecimal notation.

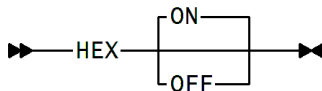

ON : Displays record data in hexadecimal notation in a three-line format. The three lines are followed by a separator line of dashes.

Line 1: Displays the data in standard character form. Valid Graphic DBCS data is displayed in DBCS form.

Lines 2 and 3: Displays the hexadecimal values of the data in Line 1, arranged vertically. Each of these lines is marked with the letter V in column 1. The high-order hexadecimal digit is displayed above the low-order hexadecimal digit.

OFF : Does not display record data in hexadecimal notation.

HIDE : Excludes fields or a range of fields from your display.

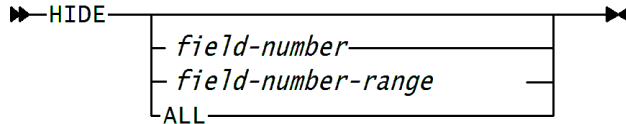

blank : If you specify the HIDE command without a parameter, File-AID displays the HIDE and HOLD Settings pop-up.

field-number : Specify the field number(s).

field-number-range : Specify the field number range(s). Reverse field range is supported.

ALL : Hides all fields and displays the HIDE and HOLD Settings pop-up.

HOLD : Specifies the ORDER of data items to HOLD on the screen while scrolling in Formatted and Vertical Format modes.

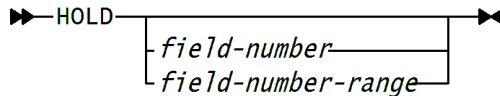

blank : If you specify the HOLD command without a parameter, File-AID displays the HIDE and HOLD Settings pop-up.

field-number : Specify the field number(s).

field-number-range : Specify the field number range(s). Reverse field range is supported.

INFO : Displays statistical information for a dataset.



INIT : Initializes and displays all fields of the current record, according to the specified record layout. Each field is initialized to a null value appropriate to the field format.

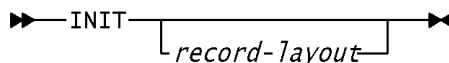

record-layout : Specifies the record layout with which you want File-AID to initialize and display the current record.

Do not specify the *record-layout* parameter while a segmented record is being edited, unless the base (first) segment is being displayed. If the base segment is displayed, the record is initialized to contain a single segment of the specified type and any other segments are eliminated from the record.

Specifying the *record-layout* parameter while a segment other than the base segment is displayed produces the error message **CANNOT USE NAME** and prevents initialization.

INPUT / INSERT : Permits new formatted records to be created, edited, and added to a dataset.

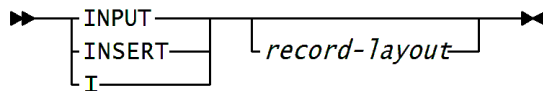

record-layout : Specifies a different record layout to use to format the new record. The specified layout must be included either as part of an XREF entry or as part of a record layout containing several 01 levels. If the specified record layout is not valid, the message **LAYOUT NOT FOUND** is produced. (Use the USE command to see the list of available record layouts.)

INPUT / INSERT (I) (Selection Criteria) : This command is available in the Selection Criteria function in Formatted and Unformatted mode. It inputs/inserts a new formatted selection criteria set or subset.

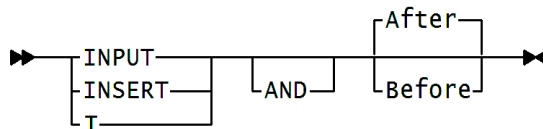

AND : Inserts an ANDed subset of selection criteria after (default) or before the current criteria set or subset.

After : Inserts a set or subset after (default) the current criteria set or subset.

Before : Inserts a set or subset before the current criteria set or subset.

INVALIDCHAR (INVCHAR or IVC) : Controls whether the character fields that include nondisplayable characters are displayed as 'INVALID' or not.

Valid in Browse and Edit in Vertical Formatted mode.

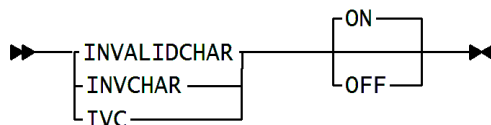

ON : Displays the character fields that include nondisplayable characters as 'INVALID'.

OFF : Displays the displayable characters and replaces nondisplayable characters by ISPF attributes.

KEY : Scrolls to the record with the specified key (VSAM-KSDS only). If you omit the key-value, File-AID displays the Key Specification screen.

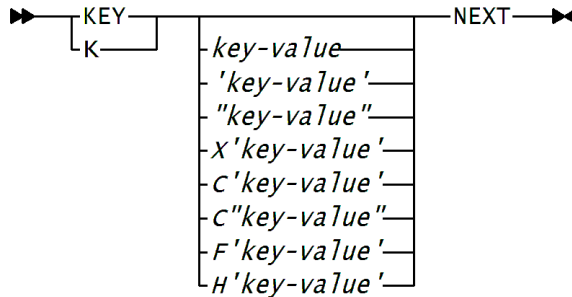

key value : Scrolls to the record with the specified key value. Use the following prefixes to distinguish the key value format:

X - Hex

C - Character (Case-sensitive)

F - Fullword (4 bytes).

H - Halfword (2 bytes).

NEXT : Retrieves the first record with a key greater than or equal to the *key-value* parameter.

LEFT : Scrolls the display to the left in character and vertical formatted modes and to the previous record in formatted mode. In character and vertical formatted modes, the default is the value in the SCROLL field. Scroll values include CSR, DATA, HALF, and PAGE.

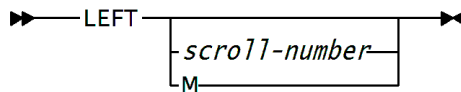

scroll-number : Specifies the number of characters to scroll to the left in character and vertical formatted modes, or the number of records to scroll back in formatted mode. Attempts to scroll left beyond column 1 or before the first (selected) record are treated as a maximum scroll.

M (maximum) : Scrolls the display to the first column of the file in character and vertical formatted modes, or to the first (selected) record of the file in formatted mode.

LEVEL : Sets the PDS modification level for a PDS member.

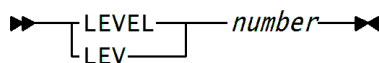

number : Specifies an integer between 1 and 99.

LISTALC : Displays the Current DDNAME Allocation List screen with a complete list of datasets allocated to you by File-AID.

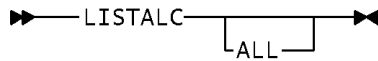

ALL : Modifies the Current DDNAME Allocation List to include all datasets allocated to your user ID.

LOCATE : Displays a specified line, line type, or field.

Individual Line Syntax (Character and Vertical Formatted Modes):

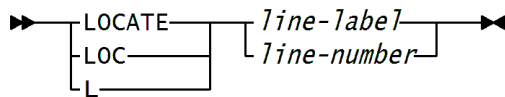

line-label : Searches for a specific line label. If the line label is found, File-AID positions that line at the top of the display. The remainder of the screen is filled, depending on the current display mode. Valid entries are a user-defined label and the File-AID-defined labels SEQ, DUP, ERR, and NEW.

line-number : Searches for a specific line number. If found, File-AID positions that line at the top of the display. Specify the line number without a preceding period. Valid line-number entries may be as large as eight digits. Leading zeros are not required.

Entering a number that is larger than the largest line number causes File-AID to position the last record at the top of the display.

Line-Type Syntax (Character, Vertical Formatted, and Unformatted Modes):

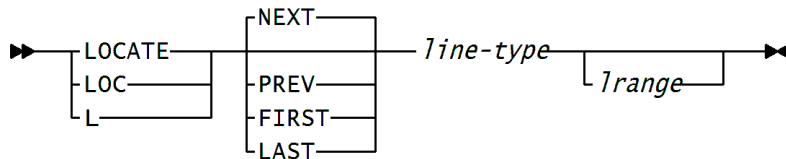

NEXT, PREV, FIRST, LAST : Specifies the starting point and direction of a line search.

line-type : Searches for a specific type of line. If found, positions the line at the top of the display. This parameter is required.

Valid entries for line-type are: CHANGE (CHG), COMMAND (COM,CMD), DUPKEY (DUP), ERROR (ERR), EXCLUDED (X), LABEL (LAB), NEW, SEQERR (SEQ), and SPECIAL (SPE).

lrange : Confines the search to a specified range of lines (records). For the line range limits, use any combination of user-defined labels, system labels, or valid line numbers, prefixed by a period.

Field Syntax (Formatted and Vertical Formatted Mode):

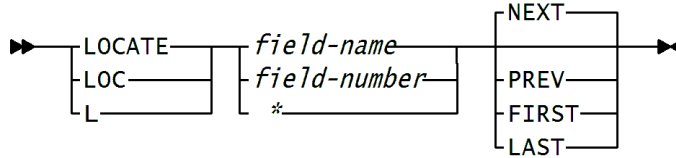

field-name, field-number : Searches for the specified field name or a field number. If found, File-AID positions the field to the top of the display.

***** (**asterisk**) : Used in place of the *field-name* or *field-number* parameter to reuse the field name or field number supplied from the previous LOCATE command.

NEXT, PREV, FIRST, LAST : Specifies the starting point and direction of a field search.

LR : Scrolls forward or backward to a specified record number, label, or any record with a label classification.

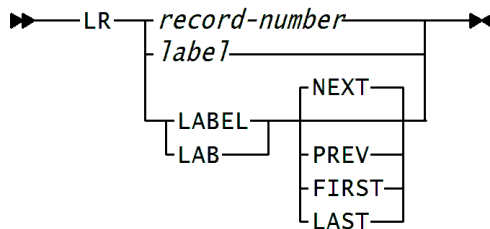

record-number : Specifies the record to which you want to scroll. You can enter a record number of up to 10 digits. If you enter a value that exceeds the number of records in the file, File-AID displays the last record in the file.

label : Specifies the label to which you want to scroll. In character and vertical formatted modes, assign a label by scrolling to any line and entering a label in the sequence number field. In formatted mode, assign a label by entering the label on the command line. The label is a period followed by up to five characters.

LABEL (LAB) : Locates an occurrence of a record having a user-specified label.

NEXT, PREV, FIRST, LAST : Use the NEXT, PREV, FIRST, or LAST values to locate the next, previous, first, or last occurrence of a labeled record.

MAP : Changes the display to formatted mode.



MERGE : Imports records from another dataset and inserts them in the correct key order.

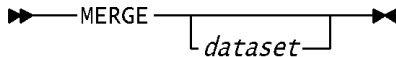

dataset : Specifies the name of the dataset to use as a source of new records.

Entering the MERGE command while editing a nonkeyed dataset produces the message **COMMAND NOT SUPPORTED**. The command is ignored.

MESSAGE : Controls the display of the mode prompt message line available at the bottom of the browse and edit screens.

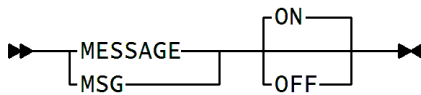

NEXT : Relocates the display to the segment after the currently displayed segment in the same record.

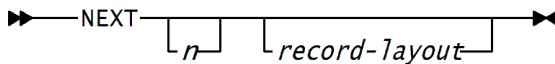

n : Specifies the number of segments to advance the display. The default for the *n* parameter is 1 (advance one segment).

record-layout : Specifies that a segment matching the XREF criteria for the specified record layout is to be displayed. If the specified record layout does not match the name of a currently loaded record layout, the message **RECORD LAYOUT NOT FOUND** is displayed.

OCCURS : Controls the display of array declaration lines.

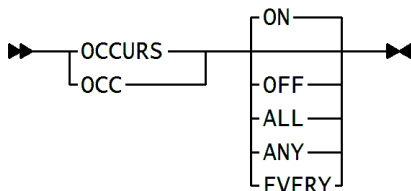

ON : Displays an array definition line for each subscripted item in a record layout.

OFF : Does not display an array definition line.

Selection Criteria Functionality

ANY, EVERY and ALL are only available in Formatted Selection Criteria.

ALL : Displays all occurrences separately with the subscript(s) and any criteria entered on a specific occurrence will only be applied to that occurrence.

ANY : Displays a single entry for the occurrences and any criteria entered for the ANY occurrence will be applied to all occurrences. The record will meet the Selection Criteria if **any** of the occurrences meet the specified criteria. ANY is applied for initial display of Selection Criteria.

EVERY : Displays a single entry for the occurrences and any criteria entered for the EVERY occurrence will be applied to all occurrences. The record will meet the Selection Criteria if **all** of the occurrences meet the specified criteria.

OFFSET : Use the SHOW OFFSET command to display the field offsets. Then use the OFFSET primary command to set the format for the display of field offset information.

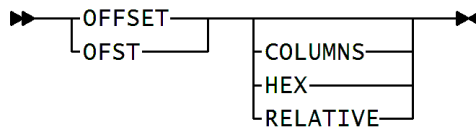

COLUMNS (COL, C) : Lists the column in which each data field begins, starting in record column 1. Changes the field description heading to COLUMNS. The offset of the first field is displayed as 1, and the offsets of all fields that follow are also greater by 1 than the offsets displayed when the OFFSET option is set to REL(HEX).

HEX (H, X) : Displays the offset of each field from the beginning of the record in hexadecimal form. Changes the field description heading to REL(HEX).

RELATIVE (REL, R) : Displays the offset of each field from the beginning of the record. Changes the field description heading to RELATIVE. The offset of the first field is zero.

OPT : In Selection Criteria (Option 6), displays the Selection Criteria Options screen.

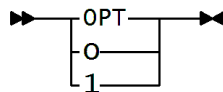

OVERLAY : Displays, sets, or modifies an overlay mask.

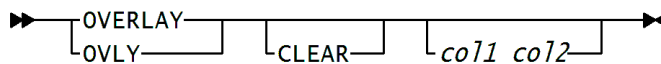

CLEAR (C) : Resets the overlay mask to all blanks.

col1 col2 : Specifies a column range.

PAD : Changes the value of the pad character.

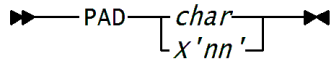

char : Specifies a new value for the pad character. If the new value is a blank or a comma, it must be enclosed in apostrophes (').

X'nn' : Sets the pad character to a nondisplayable value, where *nn* is two hexadecimal digits enclosed in apostrophes (').

PAIR : The PAIR command scrolls the top and bottom portions of the panel to the same associated field. Type PAIR in the COMMAND line and position the cursor on the associated field you want to locate, then press ENTER. Both the top and bottom portions of the panel position to the field where the cursor is positioned. The command is only available in the "Compare - Associate Field Names" panel in Formatted Compare mode.

PASTE : Copies the "CUT file" sequentially into the current File-AID Edit file. Specify the destination with the A (after), B (before), or H (here) line command or the AFTER <label> or BEFORE <label> parameter. When the Edit file is empty, you do not need to enter the destination.

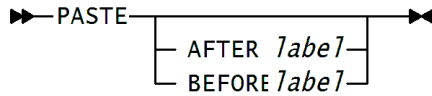

AFTER/BEFORE label : Paste the cut file after or before a specific user-defined line label (.label).

PICTURE : Controls the display of the PICTURE or DISPLAY line for numeric data.

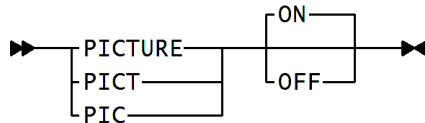

PRESERVE : ON (default) maintains trailing blanks (spaces) in variable length records. Valid only for Edit and Copy functions being performed on variable length records.

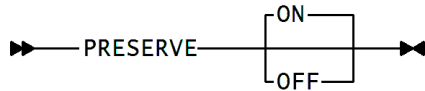

PREV : Displays the previous fixed-length segment in the current record.



PROFILE : Displays profile information lines. Use the RESET primary command to delete the profile information lines from the display.

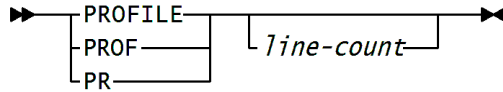

line-count : Specifies the number of information lines to be displayed.

PROTECT : Sets the protection of key fields for the currently displayed segment or record to prevent the fields from being modified.

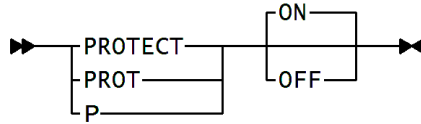

RBA : Locates a relative byte/block address (RBA) value in Browse and Edit functions for ESDS files. It positions the display to a specific record within a VSAM-ESDS file based on the record's RBA.

▶▶ RBA - *n* ▶▶

RCHANGE : Repeats execution of the previous CHANGE command.

▶▶ RCHANGE ▶▶

REBUILD : Discards changes made in the current formatted record without exiting the edit session.

▶▶ REBUILD ▶▶

RECORD (REC) : Closes the Global Selection Criteria panel and returns to the Formatted Selection Criteria panel. Only valid on the Global Selection Criteria panel.

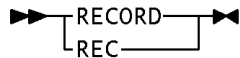

REDEFINES : Controls the display of data item redefinitions.

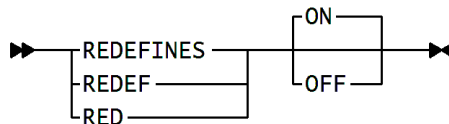

REFLNG : Controls the display of BIT/CHAR VARYING field length reference lines for PL/I data.

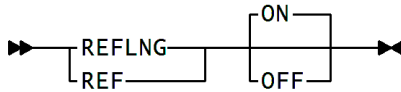

REMOVE : Deletes the currently displayed segment from the record.

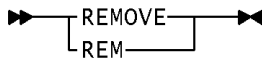

REPEAT : Inserts one or more copies of a record immediately after the record.

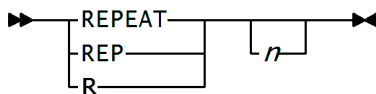

n : Specifies the number of copies of the displayed record to insert immediately after the current record. This parameter is valid only in Formatted Edit.

REPEAT (Selection Criteria) : This command is available in the Selection Criteria function in Formatted and Unformatted mode.

The REPEAT command inserts a copy of the current selection criteria set after the current criteria. REPEAT by itself copies a whole set, including any subsets. REPEAT AND copies only the current subset.

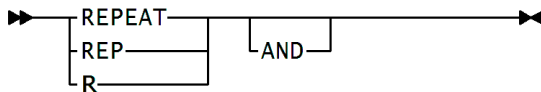

AND : Inserts a copy of the current set or subset of selection criteria after the current set or subset as an ANDed subset. The criteria set number is NOT incremented but the subset number is (AND SET 3.3 of 4).

REPLACE : Overwrites the contents of an existing dataset.

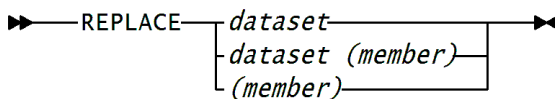

dataset : Specifies the name of the dataset to which records are to be written.

dataset(member) : Specifies the PDS dataset and member name to which records are to be written.

(member) : To overwrite a member in the same PDS as the member being edited, specify the member name enclosed in parentheses.

RESET : In character and vertical formatted edit, cancels information displays; displays excluded lines; removes line types from display. In character browse, RESET removes the COLS information line. In formatted mode, cancels profile information.

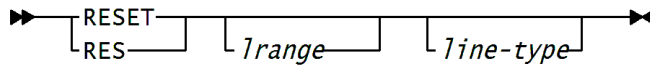

range : Confines the RESET command to a specified range of lines (records). The line range may be specified using one or two line labels or line numbers. For the line range limits, use any combination of user-defined labels, system labels, or line numbers (prefixed by a period).

line-type : Specifies types of information flags to be eliminated from the display. Omitting the *line-type* parameter is equivalent to specifying all line types except LABEL. Valid line-type values are: CHANGE, COMMAND, ERROR, EXCLUDED, HIDE, HOLD, LABEL, NEW, and SPECIAL.

RETURN : Returns to the Primary Option Menu.



RFIND : Repeats execution of the previous FIND command.



RIGHT : Scrolls the display to the right in character and vertical formatted modes, and to the next record in formatted mode. In character and vertical formatted modes, the default is the value in the SCROLL field. Scroll values include CSR, DATA, HALF, and PAGE.

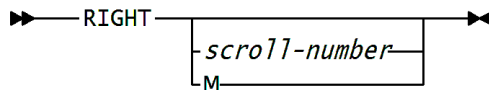

scroll-number : Specifies the number of characters to scroll to the right in character and vertical formatted modes, or the number of records to scroll forward in formatted mode.

M (maximum) : Scrolls the display to the right-most character in character and vertical formatted modes, or to the last (selected) record of the file in formatted mode.

RLOC : Repeats execution of the previous LOCATE command.



SAVE : Writes the edit buffer to the dataset being edited.

▶▶—SAVE—◀◀

SELECT (SEL) : Closes the Data Replace Criteria panel and returns to the Global Selection Criteria panel. Only valid on the Data Replace Criteria panel.

▶▶—SELECT
|
SEL—◀◀

SETUNDO : Enables/disables the use of the UNDO command (change recording). Initial setting is on.

▶▶—SETUNDO—◀◀
|
SETU—
|
-ON—
|
-OFF—

SHOW : Displays LEVEL, NUMBER, FORMAT, OFFSET, or PICTURE information for a record.

Field Name Syntax:

▶▶—SHOW—◀◀
|
S—
|
-LEVEL—
|
-NUMBER—

LEVEL (L) : Displays the record's hierarchical level number at the left of each data item name, and changes the heading of the Field Name area to FIELD LEVEL/NAME. File-AID indents each successive level two character positions to emphasize the record structure. When this parameter is used, the Field Name area closely resembles the original (source) record layout declaration.

NUMBER (N) : Displays the field numbers assigned by File-AID, and changes the heading of the Field Name area to FIELD NUMBER/NAME. Field numbers are assigned sequentially, beginning at the top of the record layout. Each elementary or group data item name is assigned a unique field number. Each occurrence of a data item that has multiple occurrences is assigned the same field number, since all occurrences share the same data name.

Field Description Syntax:

▶▶—SHOW—◀◀
|
S—
|
-FORMAT—
|
-OFFSET—
|
-PICTURE—

FORMAT (F) : Displays field length and current field format, separated by a slash (/), and changes the heading of the Field Description area to FORMAT. The field length is expressed in bytes.

OFFSET (O) : Displays the offset of each field from the beginning of the record. The offset can be expressed in three ways: relative, hexadecimal, or columns. Specify the offset format with the OFFSET command.

PICTURE (P) : Displays a representation of the original data declaration for each elementary item, and changes the heading of the Field Description area to PICTURE.

SORT : Sorts specified records based on the contents of sort fields.

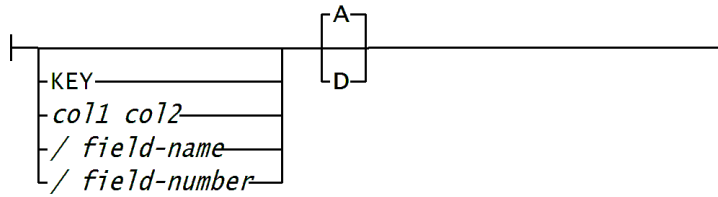
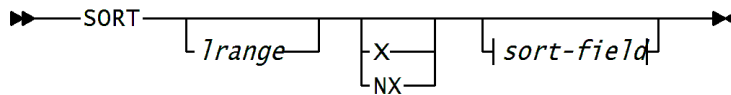

lrange : Confines the sorting operation to a specified line range (records). The line range is specified with two line labels. Use any combination of user-defined labels, system labels, or line numbers (prefixed by a period).

X, NX : Confines the scope of the SORT command to excluded (X) or non excluded (NX) lines. If the *lrange* parameter is also specified, only excluded or non excluded lines within the specified line range are sorted.

Lines are excluded using the EXCLUDE primary command or the X (exclude) line command. Excluding lines divides the edit dataset into two subsets, either of which may be processed separately by the SORT command.

sort-field : Specifies from one to five sort fields. If no *sort-field* parameters are specified, the data within the edit bounds is used and the data is sorted in ascending sequence.

KEY: Used as one of the five sort fields when editing a keyed dataset, RRDS or BDAM dataset. Specifying KEY is equivalent to specifying the two-column numbers delimiting the record key. The letters A or D may not be used to define the sorting sequence with KEY because the sort is always in ascending sequence. RRDS and BDAM records are sorted in RRN (or RBN for BDAM) order.

If other *sort-field* parameters are specified along with KEY, they cannot overlap the key field. The remaining *sort-field* parameters may also be modified by the A or D parameters.

col1, col2: Specifies column numbers for each *sort-field* parameter. The two column numbers must be listed together; the second column number of each pair must be greater than or equal to the first column number.

If a specified sort field extends beyond the end of a variable-length record, that record is sorted as if the columns beyond the end of the record contained null characters (hex 00). If multiple *sort-field* parameters are specified, they must not overlap.

/field-name, /field-number: The */field-name* parameter specifies the data name given to the field in the record layout. The */field-number* parameter specifies the number generated by File-AID for each data name in the record layout.

A (default), D: Specifies ascending (A) or descending (D) order for the *sort-field* parameter. If an A or D parameter is specified with any *sort-field* parameter, all other *sort-field* parameters must be accompanied by one of the two letters. List the A or D before or after the corresponding column pair, not between *col1* and *col2*.

STATS : Controls the generation of statistics when a PDS is edited.

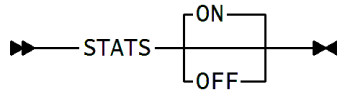

SUBMIT : Submits the file you are browsing or editing as a batch job for backgroundprocessing. SUBMIT is valid in Character mode only.

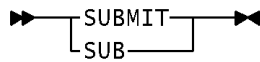

SYNC : Controls the display of the SYNC term for fields in a COBOL record layout.

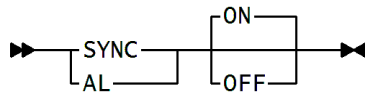

TOP : Displays the base segment of the current record.



UNDO : Restores the dataset to its condition prior to the last accepted change entry. Valid in the Edit function in all modes and the Field-to-Field Selection Criteria screen.



UNFMT : Invokes unformatted mode from character, formatted, and vertical formatted modes of Browse and Edit.

▶—UNFMT—◀

In Selection Criteria (Option 6), displays the Unformatted Selection Criteria screen.

▶—UNFMT—◀
 |—U—
 |—3—

UP : Scrolls the display up. Default is the value in the SCROLL field. Scroll values include CSR, DATA, HALF, and PAGE.

▶—UP—◀
 |—scroll-number—
 |—M—

scroll-number : Number of lines to scroll up.

M : Scrolls up the maximum amount. The effect of this parameter varies by mode:

- **Character and Vertical Formatted:** Scrolls up to display the first (selected) record in the file.
- **Formatted:** Scrolls up to display the first line of the current layout at the top of the screen.

USE : Formats a record or specifies another record layout for the current record.

▶—USE—◀
 |—offset— |—record-layout—
 |—NEXT— |—*—
 |—PREV—

offset : Specifies either a column (absolute) offset from the beginning of the record, or an offset relative to the currently displayed position in the record. You must preface a relative offset number with a plus or minus sign (+ or -). If you do not specify an offset, the position of the currently displayed record is used.

NEXT : Directs File-AID to use the offset of the position immediately after the current segment, that is, the end of the currently selected record layout.

PREV : Specifies that File-AID is to display the previous segment. Using this parameter is subject to the same restrictions as those for the PREV command.

Note: The parameters **offset**, **NEXT**, and **PREV** are not valid in VFMT mode.

record-layout : Specifies a currently loaded record layout. When an XREF is in use, only the 01 levels directly referenced may be specified. Any unique abbreviation of the record layout name can be specified.

***** (asterisk) : Enter an asterisk (*) in place of the *record-layout* parameter to retain the currently selected record layout.

VERSION : Sets the PDS version number for a PDS member.

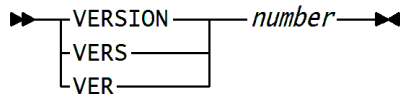

number : Specifies the PDS version number when a PDS member is edited.

VFMT : Invokes vertical formatted mode from character, formatted, and unformatted modes of Browse and Edit.



VIEW : In the Selection Criteria function (Option 6), **VIEW** displays a screen summarizing the specified options and all the sets of formatted and unformatted selection criteria in a scrollable display. In the XREF function (Option 7), **VIEW** is valid on the Define XREF screen and displays the entire XREF in a scrollable display.

In Option 3.5 (VSAM utility), the **VIEW** command displays IDCAMS messages generated by the IDCAMS utility.

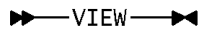

VPRINT : Prints one or more records in vertical formatted mode, presenting the data according to a COBOL or PL/I record layout. Use the **DISPLAY** primary command or the **FIELDS** parameter to tailor the current display of fields.

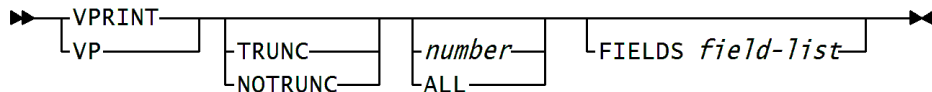

TRUNC : It **TRUNC** processes the **VPRINT** request online and truncates each print line if the vertically formatted record exceeds the print width. The default is set in Option 0.3 with the "Truncate for VPRINT cmd" parameter. This is the standard form that has been part of the product prior to Release 9.0. Unless you have pre-allocated a print dataset **VPRINT TRUNC** continues with the "Print Parameters Screen" Screen where you specify more output options.

NOTRUNC : It **NOTRUNC** processes the **VPRINT** request in batch and prints multiple pages if the vertically formatted record exceeds the print width.

The default is set in Option 0.3 with the “Truncate for VPRINT cmd” parameter. VPRINT NOTRUNC continues with the “Vertical Format Print (VPRINT) JCL Specification” Screen where you specify more output options.

number : Specifies the number of records to print. The default is 0 or ALL. 0 (zero) prints the current and all subsequent records in the file.

ALL : Prints the current record and all subsequent records in the file.

number : For VPRINT TRUNC, specifies the number of records to print. The default is 0 or ALL. 0 (zero) prints the current and all subsequent records in the file.

For VPRINT NOTRUNC, specifies the number of records to print, starting with the first record in the file. The default is 0 or ALL. 0 (zero) prints the first and all subsequent records in the file.

ALL : For VPRINT TRUNC, prints the current record and all subsequent records in the file. Prior records are not printed.

For VPRINT NOTRUNC, prints all records in the file.

FIELDS *field-list* : Specifies any combination of field numbers and/or field number range. Separate each field number specification by a space or a comma. Specify a range with a hyphen between the starting and ending field numbers. You may specify up to nine field number specifications or 60 characters.

XMLGEN : Generates an XML formatted document into an existing, or new, dataset using any number of subsequent records.

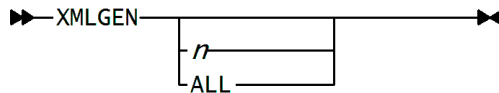

blank : The current record and all following records are used to generate the XML document.

n : Specify *n* as the number of records to use to generate the XML Document.

ALL : The current record and all following records are used to generate the XML document.

Notes:

- The XMLGEN command uses the record fields as they are displayed on the screen (see DISPLAY/HIDE commands to change the display formats).
- Excluded records and fields are never used when generating the XML document.
- When the file has segmented records defined with an XREF member, File-AID internally issues NEXT commands to format each segment of each record.

ZERO : Controls the display of leading zeros in numeric data fields.

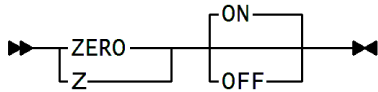

Line Commands

Enter line commands in the sequence number field. They execute after data modifications have been processed, but before primary commands are executed. Double characters define a block command. A single character or a block with a number specifies multiple iterations of the command.

Standard Edit Line Commands

The line commands listed in Table 5 are available in character and vertical formatted modes of the Edit function:

Table 5. Standard Edit Line Commands

A[n]	Marks one or more destination(s) after which one or more records is placed.
B[n]	Marks a destination before which one or more records is placed.
BNDS	Displays the column boundary information line.
C[n], CC	Copies a line or block of records to a marked destination.
CHAR	Invokes character mode from vertical formatted mode.
COLS	Displays the column number's information line.
D[n], DD	Deletes a line or block.
F[n]	Requests that the first record(s) of an excluded range of lines be unexcluded and displayed.
FMT	Displays the record in formatted mode.
H[n]	Marks one or more destinations after which one or more records is placed.
I[n]	Inserts one or more records.
L[n]	Requests that the last record(s) of an excluded range of lines be unexcluded and displayed.
M[n], MM	Moves a line or block to a marked destination.
MAP	Displays the record in formatted mode.
MASK	Displays the input mask.
O[n], OO	Marks a destination over which copied or moved data is overlaid.
OVLY	Displays the overlay mask information line.
P[n], PP	Protects a line or block from key modification.
R[n], RR[n]	Repeats a line or block.
S	Requests that an entire group (range) of excluded records be unexcluded and displayed.
	Displays the specified record in formatted mode when entered on a line that is not excluded. Also selects a member from a member list.
	In the Compare function, the S line command selects a line for comparison.

Table 5. Standard Edit Line Commands

U [<i>n</i>], UU	Unprotects a line or block from key modification.
VFMT	Invokes vertical formatted mode from formatted and character modes.
X [<i>n</i>], XX	Excludes a line or block from the display.
([<i>n</i>], (([<i>n</i>]	Shifts a line or block one or more positions to the left.
) [<i>n</i>],)) [<i>n</i>]	Shifts a line or block one or more positions to the right.

Windowed Edit Line Commands

The line commands listed in Table 6 are available in character and vertical formatted modes of the Windowed Edit function:

Table 6. Windowed Edit Line Commands

BNDS	Displays the column boundary information line.
CHAR	Invokes character mode from vertical formatted mode.
COLS	Displays the column number's information line.
D [<i>n</i>], DD	Deletes a line or block. The DD block command is supported only in the current window.
FMT	Displays the record in formatted mode.
I [<i>n</i>]	Inserts one or more records.
MAP	Displays the record in formatted mode.
MASK	Displays and allows edit of the mask information line.
R [<i>n</i>]	Repeats a line.
S	Displays the specified record in formatted mode.
VFMT	Invokes vertical formatted mode from formatted and character modes.

File-AID/Batch

This section summarizes File-AID/Batch functions and parameters. For detailed information, refer to the *File-AID/MVS Batch Reference Manual*.

Control Cards

Control cards determine the process to be performed on the input file. Control card continuation must begin in column 2. The basic format is:

```
$$DDxx FUNCTION PARAMETER(S) COMMENT(S)
```

\$\$DDxx is the dataset identifier used to connect the control statement to the input file. Specify the input file in the JCL as //DDxx. xx is a value from 00 to 99.

FUNCTION specifies what is to happen to the input file.

PARAMETER(S) limit or identify records for processing. Parameters are separated by commas. When a blank is encountered, the remainder of the line is treated as a comment.

COMMENT(S) appear on the SYSPRINT output dataset when the function is completed. A comment can also be coded on a control card by placing an asterisk (*) in location 1.

Sample JCL Statements

The JCL used to execute File-AID/Batch follows the same format and structure as a typical MVS batch job. Some statements are optional, depending on function. The JCL must include a job statement, execution statement, and data definition statements for all input and output files.

```
//JOBNAME JOB JOB CARD INFORMATION
//STEPNAME EXEC PGM=FILEAID
//STEPLIB DD DSN=File-AID LOAD LIBRARY NAMES
//STPCAT DD DSN=CATALOG NAME
//SYSPRINT DD SYSOUT=A
//SYSLIST DD SYSOUT=A
//SYSTOTAL DD SYSOUT=A
//DDxx DD DSN=INPUT DATASET NAME
//DDxx0 DD DSN=OUTPUT DATASET NAME
//DDxxRF DD DSN=REFORMAT DEFINITION DATASET NAME
//DDxxRL DD DSN=RECORD LAYOUT DATASET NAME
//DDxxRLN DD DSN=RECORD LAYOUT DATASET NAME COMPARE NEW
//DDxxXR DD DSN=XREF DATASET NAME
//DDxxXRN DD DSN=XREF DATASET NAME COMPARE NEW
//DDxxSC DD DSN=SELECTION CRITERIA DATASET NAME
//DDxxSC DD DSN=SELECT CRIT DATASET NAME COMPARE NEW
//DDxxCP DD DSN=COMPARE CRITERIA DATASET NAME
//DDxxC DD DSN=NEW COMPARE DATASET NAME AND MEMBER NAME
//DDxxCO DD DSN=NEW COMPARE OUTPUT FILES
//anyname DD DSN=WRITE PARAMETER OUTPUT DATASET NAME
//SYSIN DD *
(CONTROL CARDS)
/*
//
```

Function/Parameter Compatibility

Most parameters can be used with any function, but some are ignored during certain functions. The following table shows parameter availability by function.

Table 7. Function/Parameter Compatibility

Parameter	Function																								
	APRINT	COMPARE	CONVERT	COPY	DROP	DUMP	FPRINT	LIST	LMODDIR	LMODMAPA	LMODMAPN	PRINT	REFORMAT	RLPRINT	SCPRINT	SPACE	TALLY	UPDATE	USER	VPRINT	VTOCDSN	VTOCINFO	VTOCMAP	XMLGEN	XRPRINT
ABEND				X	X	X	X	X				X				X	X	X	X	X					
ACCUM				X	X	X	X	X				X				X	X	X	X	X					
AMODE									X	X	X														
AND				X	X	X	X	X				X				X	X	X	X	X					
AUDIT				X	X													X							
CCSID	X						X													X				X	
CEM				X	X																				
CHANGED				X	X	X	X	X				X		X	X	X	X	X	X	X					X
CHARSET		X		X	X	X	X	X				X	X			X	X	X	X	X					
COPTNS		X																							
CREATED				X	X	X	X	X				X		X	X	X	X	X	X	X					X
DFLT_WRITE																			X						
DROP					X																				
DSNAME																					X		X		
DUMP				X	X											X	X	X	X						
EDIT				X	X	X	X	X				X				X		X	X	X					
EDITALL				X	X	X	X	X				X				X		X	X	X					
ELSE*																	X		X						
ERRS				X	X	X	X	X				X				X	X	X	X	X					
EXPAND				X	X	X	X	X				X				X	X		X	X					
EXPAND_OCCURS														X											X
FEOV				X	X														X						
FIELDS																									
FILLER							X														X				
FORM	X	X		X	X	X	X	X				X						X	X	X					
FPRINT				X	X											X	X	X	X						
IF				X	X	X	X	X				X				X	X	X	X	X					
IFNOT				X	X	X	X	X				X				X	X	X	X	X					
IN				X	X	X	X	X				X				X	X	X	X	X					
INVALID																								X	
INVALIDCHAR																					X				
IOEXIT		X		X	X	X	X	X				X	X			X	X	X	X	X					
KEY				X	X	X	X	X				X				X	X	X	X	X					
KEYINFO			X																						
LANGTYP				X	X	X	X	X				X				X	X	X	X	X					X
LAYOUT							X																	X	
LINKDATE								X	X	X														X	
LIST				X	X											X	X	X	X						

Table 7. Function/Parameter Compatibility (Continued)

Parameter	Function																								
	APRINT	COMPARE	CONVERT	COPY	DROP	DUMP	FPRINT	LIST	LMODDIR	LMODMAPA	LMODMAPN	PRINT	REFORMAT	RLPRINT	SCPRINT	SPACE	TALLY	UPDATE	USER	VPRINT	VTOCDSN	VTOCINFO	VTOCMAP	XMLGEN	XRPRINT
LPI				X	X	X	X	X				X				X	X	X	X	X					
MAP							X	X											X	X					
MAXENT				X	X	X	X	X				X						X	X	X	X				
MAXOUT																			X	X					
MBRNAME				X	X	X	X	X	X	X	X	X		X	X	X	X	X	X	X	X				X
MEMBER				X	X	X	X	X	X	X	X	X		X	X	X	X	X	X	X	X			X	X
MEMBERS				X	X	X	X	X	X	X	X	X		X	X	X	X	X	X	X	X			X	X
MOVE				X	X	X	X	X				X				X			X	X					
NEWMEM				X	X														X						
NEWMEMS				X	X														X						
ORIF				X	X	X	X	X				X				X	X	X	X	X	X				
ORIFNOT				X	X	X	X	X				X				X	X	X	X	X	X				
OUT				X	X	X	X	X				X	X						X	X				X	
PADCHAR				X	X	X	X	X				X				X			X	X					
PANSTAT				X	X	X	X	X				X				X	X		X	X					
PDSSTAT																		X							
PRESERVE				X															X						
PRINT		X		X	X											X	X	X	X						
PRTRECS		X																							
RBA				X	X	X	X	X				X				X	X	X	X	X	X				
RDW				X	X	X	X	X				X				X	X	X	X	X	X				
READ NEXT *																	X		X						
REFOUT													X												
REPL				X	X	X	X	X				X				X		X	X	X	X				
REPLALL				X	X	X	X	X				X				X		X	X	X	X				
RLM				X	X														X						X
RLPRINT																									
RMODE									X	X	X														
RRN				X	X	X	X	X				X				X	X	X	X	X	X				
SELECT				X	X	X	X	X				X				X	X	X	X	X	X				
SHOW							X	X													X				
STOP				X	X	X	X	X				X				X	X	X	X	X	X				
TYPE			X																						
TYPRUN		X																							
UNIT																						X	X	X	
USERID				X	X	X	X	X				X		X	X	X	X	X	X	X	X	X			X
VOLSER																						X	X	X	
VOLSTAT																						X	X	X	
VPRINT				X	X											X	X	X	X						
WRITE																			X						
ZERO							X													X				X	

* This parameter is also compatible with COPYALL, DUMPALL, FPRINTALL, LISTALL, PRINTALL, UPDATEALL, and VPRINTALL.

Functions

APRINT (AP)

Prints the audit trail file in formatted, character, or hexadecimal format. The audit trail file is created by File-AID online. Must be the last control card. The input audit trail dataset must be DD01.

COMPARE

Compares the contents of two files. Specify the old dataset in DDxx, the new dataset in DDxxC, and the compare criteria in DDxxCP. The compare criteria dataset can be created from File-AID online Option 10 (Compare) or coded in batch.

CONVERT

Converts existing File-AID Release 6 selection tables and Release 7 XREFs to File-AID Release 8's XREF format. It also converts File-AID Release 7.0 saved selection criteria to File-AID Release 8's saved selection criteria format. In addition, CONVERT is used to convert File-AID for IMS and File-AID for DB2 XREFs to the File-AID/MVS Release 8 XREF format.

COPY (C)

Copies data selectively or nonselectively. Parameters specify selective or limited copying. Records can be copied as is or modified.

DROP (DR)

Eliminates unwanted records from a dataset while copying it. Parameters specify records to be dropped.

DUMP (D)

Prints datasets in vertical hexadecimal format. Parameters select records for printing. Uses the system default limit unless overridden by the OUT parameter.

FPRINT (FP)

Prints one or more records in formatted mode, showing the data according to a COBOL or PL/I record layout.

LIST (L)

Prints alphanumeric data. Packed, binary, and other unprintable data are shown as blanks. Uses the system default limit unless overridden by the OUT parameter.

LMODDIR (LMD)

Lists directory entry(ies) of member(s). Optional parameters CHANGED, CREATED, MBRNAME, MEMBER, and MEMBERS enable you to select specific members for processing.

LMODMAPA (LMA)

Lists modules (maps CSECTS) in address order. Optional parameters AMODE, RMODE, and LINKDATE select specific modules based on address or residency mode and/or link date range. Optional parameters MBRNAME, MEMBER, and MEMBERS select specific members for processing.

LMODMAPN (LMN)

Lists modules (maps CSECTS) in names order. Optional parameters AMODE, RMODE, and LINKDATE select specific modules based on address or residency mode and/or link date range. Optional parameters MBRNAME, MEMBER, and MEMBERS select specific members for processing.

PRINT (P)

Prints alphanumeric data and labels each record with its record number and RBA. Packed, binary, and other unprintable data are shown as blanks. Parameters control selective processing and the number of records. Uses the system default limit unless overridden by the OUT parameter.

REFORMAT (R)

Reformats data as it is being copied. This function requires a reformat definition created with File-AID's Reformat utility (Option 9).

RLPRINT (RLP)

Prints a COBOL or PL/I record layout displaying the field level, field name, format, field number, start location, end location, and field length.

SCPRINT (SCP)

Prints the dataset containing selection criteria created from File-AID online functions.

SPACE (S)

Moves the current record pointer through the input file. The IN or STOP parameter limits the function.

TALLY (T)

Allows selection parameters to be combined with ACCUM parameters to provide audit-type totals for files. If a SYSTOTAL DD statement is not present, the report appears on the SYSPRINT DD.

UPDATE (UP)

Alters records on a file. Parameters such as EDIT or REPL specify data values to be changed. Files are updated in place. Runs only on DASD files.

USER (US)

Performs a copy function that provides greater control over the writing of output records and datasets. USER can insert new records at any point in a dataset, repeat records with changed data, and write multiple output datasets from a single input dataset.

VPRINT (VP)

Prints one or more records in vertical formatted mode, showing the data according to a COBOL or PL/I record layout.

VTOCDSN (VTD)

Displays VTOC summary information and dataset names in alphabetical sequence. This function is equivalent to File-AID's online VTOC Utility (3.7) option BLANK (List VTOC entries in dataset name sequence).

VTOCINFO (VTI)

Displays volume information including volume serial number, device type, mount status, percentage of volume allocated, VTOC statistics, VTOC index indicator, and DSCB and free space statistics. This function is equivalent to File-AID's online VTOC Utility (3.7) option I (List volume information).

VTOCMAP (VTM)

Displays volume and dataset information in address location sequence. This function is equivalent to File-AID's online VTOC Utility (3.7) option M (Map VTOC entries in pack location sequence).

XMLGEN

Creates XML documents from existing files using COBOL or PL/I layout fields as the tag names.

XRPRINT (XRP)

Prints record layout cross reference (XREF) dataset.

Function Modifiers

ALL (A)

Processes all occurrences of selection criteria and all records on the file.

- COPYALL (CA)
- DUMPALL (DA)
- FPRINTALL (FPA)
- LISTALL (LA)
- PRINTALL (PA)
- UPDATEALL (UA)
- VPRINTALL (VPA)

BACK (B)

Processes sequential or VSAM datasets backwards.

- COPYBACK (CB)
- DUMPBACK (DB)
- FPRINTBACK (FPB)
- LISTBACK (LB)
- PRINTBACK (PB)
- SPACEBACK (SB)
- VPRINTBACK (VPB)

MEMBER (MEM)

Processes a PDS on a member level; if a record meets the selection criteria, the function is performed on the entire member.

- COPYMEM (CM)
- DUMPMEM (DM)
- FPRINTMEM (FPM)
- LISTMEM (LM)
- PRINTMEM (PM)
- VPRINTMEM (VPM)

Parameters

Descriptions and values for parameter elements are given in “Parameter Elements” on page 72.

ABEND (AB)

Sets end-of-job (EOJ) processing based on abnormal conditions during execution.

AB=[*n*]

Values for *n* are:

- 0 Complete normal EOJ and reflect the highest return code.
- 1 (Default) Complete normal EOJ and initiate a user abend without a dump only when an I/O error occurs.
- 2 Initiate a user abend without a dump for any non-zero return code.
- 3 Terminate all processing and produce a dump at the first I/O error.
- 4 Terminate all processing and produce a dump if the number of data checks specified in the ERRS parameter is surpassed.

ACCUM (A)

Accumulates specified fields in the input records.

Character or Binary Data Accumulation Syntax:

A=(*location*,*length*,*data-type*['*description*'])

Packed Decimal Data Accumulation Syntax:

A=(*location*['*description*'])

Valid data-type codes are:

- B Binary
- C Character
- P (Default) Packed.

Use up to 25 characters in the optional description.

AMODE

Specifies the address mode to select. Valid only with the LMODMAPA, LMODDIR, LMODMAPN functions.

AMODE={ 24
 { 31
 { ANY }

AND

See “IF (AND, ORIF)” on page 64.

AUDIT (AUD)

Creates an Audit trail dataset and writes before and after images of changed/unchanged records.

AUDIT=(*x*,SPACE(*space-unit*, *primary-quantity*, *secondary-quantity*),
 STORCLAS(*storage-class*), DATACLAS(*data-class*),
 MGMTCLAS(*management-class*))
 PREFIX(*a.b.c*),PRINT(*format*))

x : Value of Y, A, or N. The values are defined as:

- Y** Create Audit trail for changed record only
- A** Create Audit trail for all records
- N** (Default) Do not create Audit trail.

CCSID

Defines the CCSID for Unicode conversion when format-printing the record. The value of *nnnnn* must be numeric (0 through 99999) of valid CCSID. Valid only with the APRINT, FPRINT, VPRINT, and XMLGEN functions

```
CCSID=nnnnn
```

CEM

Copies empty members of a partitioned dataset.

```
CEM={N}
      {Y}
```

CHANGED (CHA)

Selects a group of members from a PDS based on the member's last modified date. The from or to-date range is specified in the yy/mm/dd format.

```
CHA=(from-date,to-date)
     (to-date)
     (from-date)
     from-date
```

CHARSET (CHR)

Defines the character set from the code page table to determine which language set to use. The value of *xxxx* equals the last four characters of the language code.

```
CHR=xxxx
```

COPTNS

Specifies additional options for the condensed Compare reports. This parameter is valid only for condensed compare. Condensed compare is for Character and Hexadecimal print formats.

```
COPTNS=(suppress print,ruler,changed data char,key field char)
```

CREATED (CRE)

Selects a group of members from a PDS based on the member's creation date. The from or to-date range is specified in the yy/mm/dd format.

```
CRE=(from-date,to-date)
     (to-date)
     (from-date)
     from-date
```

DFLT_WRITE (DW)

Specifies a default output file during a USER function. It is executed when a WRITE parameter has not been executed for the current record. The output dataset is defined on a corresponding JCL DD statement called "anyname".

```
DW=anyname
```

DROP (DR)

Controls the number of records dropped from a dataset during a DROP function. Use an IF parameter with the DROP parameter.

DR=*n*

DSNAME (DSN)

Limits the VTOC processing to dataset names that match a unique dataset or a dataset specified with pattern characters.

DSN=*dataset-name*

DUMP (D)

Prints *n* records in vertical hexadecimal format while performing a function. DUMP=0 dumps all selected records.

D=*n*

EDIT (E)

Replaces the first occurrence of a character or hexadecimal data in fixed or variable length records with data of a different length. Remaining data in the record is shifted to accommodate the change.

E=(*location*,{*length* },[dup]*compare-data*,*new-data*)
{*operator*}

EDITALL (EA)

Edits all occurrences of data within the area specified by a start location and a length.

EA=(*location*,*length*,*compare-data*,*new-data*)

ELSE

Enables you to code actions to perform when the preceding conditional statement is false.

ELSE

ERRS (ERR)

Alters the number of data checks allowed per tape dataset during each execution. Specify 0 to 99; 0 specifies unlimited errors.

ERR=*n*

EXPAND

Specifies whether to expand valid CA Panvalet or Librarian INCLUDE statements.

EXPAND={*Y*}
{*N*}

EXPAND_OCCURS

Specifies whether to print all occurrences (YES) or only the first occurrence of each field when a record layout contains an OCCURS or ODO.

EXPAND_OCCURS={*Y*}
{*N*}

FEOV (FE)

Forces end-of-volume (EOV) processing for an output dataset when the input dataset reaches EOV.

```
FE={Y}
   {N}
```

FIELDS

Specifies which field numbers in the record to print in vertical formatted mode. This parameter is valid only for the VPRINT function.

```
FIELDS=(field-list)
```

FILLER

The FILLER parameter specifies whether filler fields will be printed or not. This parameter is valid only for the FPRINT and VPRINT functions.

```
FILLER=[ON/OFF]
```

FORM (F)

JCL format syntax processes the input data as JCL. Print format syntax specifies the print format for DUMP, LIST, and PRINT functions and parameters. Multiple-pass processing syntax specifies whether File-AID allows multiple-pass processing. Audit trail print syntax specifies the print format for the APRINT function.

Compare format syntax specifies the print, report, and data format, and report style for the COMPARE function. The syntax order **must** be specified as print, report, and data format, and report style. More than one FORM parameter can be used per control card.

JCL Format Control:

```
F=JCL
```

Print Format Control:

```
F={LONG }
   {SHORT}
```

Multiple-Pass Processing Control:

```
F={NOMULTI}
   {MULTI }
```

Audit Trail Print Format Control:

```
F={HEX}
   {CHAR}
```

COMPARE Format Control:

```
F={print format,report format,data format,report style}
```

The values for print format are:

- H** (Default) Hexadecimal
- F** Formatted
- C** Character.

```
INVALID={HEX}
          {DATA}
          {SKIP}
```

INVALIDCHAR (IVC)

Specifies whether the character fields that include unprintable characters will be printed as 'INVALID' or not. This parameter is valid only for the VPRINT function.

```
INVALIDCHAR=[ON/OFF]
```

IOEXIT

Specifies the input and output I/O exit names. This parameter must be the first parameter following the function and must be on the same line as the function. The exit names can be up to eight characters long.

```
IOEXIT={input-exit-name,output-exit-name}
```

KEY (K)

The Key Print syntax controls whether the key from a keyed dataset is printed. Random Key Record syntax specifies the key at which processing begins.

Key Print Control:

```
K={NO }
   {YES}
```

Random Key Record Control:

```
KEY=C'key-value'
     X'key-value'
```

KEYINFO (KIF)

Specifies whether to provide key information when converting File-AID for IMS XREFs. This parameter is valid only with the CONVERT TYPE=IMSXREF function.

```
KIF={ON}
     {OFF}
```

LANGTYPE (LAN)

Selects members based on CA Panvalet language type. This parameter is valid only for Panvalet members.

```
LANGTYP=xxxxx
```

LAYOUT

Specifies the DDxxRL dataset member used to format data for the FPRINT and VPRINT function or parameter. For the Compare function, LAYOUT specifies the member name for DDxxRL and DDxxRLN. The LAYOUT parameter is an alias for the MAP parameter.

```
LAYOUT=name
```

LINKDATE

Selects a group of members from a PDS based on the members's link date. The from or to-date range is specified in the ccy/mm/dd format. Valid only with the LMODMAPA, LMODDIR, LMODMAPN functions.

```
LINKDATE=( from-date, to-date)
          ( , to-date)
          ( from-date)
          from-date
```

LIST (L)

Prints n records of alphanumeric data without displaying record number or record length. LIST=0 prints all selected records.

```
L=n
```

LPI

Overrides the default SYSLIST line count.

```
LPI={ 6 }
      { 8 }
```

MAP

Specifies the DDxxRL dataset member used to format data for the FPRINT or VPRINT function or parameter. The MAP parameter is an alias for the LAYOUT parameter.

```
MAP=name
```

MAXENT (ME)

Changes the default maximum (1024) of input parameters permitted per execution of File-AID. Maximum entry is 999999. Must be the first parameter specified after the function name, unless the IOEXIT parameter is specified. If IOEXIT is specified, IOEXIT must immediately follow the function name followed by MAXENT.

```
ME=n
```

MAXOUT (MO)

Overrides the default (8) number of output datasets created with a USER function in conjunction with WRITE parameters. Maximum override is 99 datasets.

```
MO=n
```

MBRNAME (MBR)

Selects a group of members from a PDS based on a range of member names. The from or to member name can be up to eight characters for a PDS, PDS/E, or CA Librarian file, 10 for CA Panvalet file, and 16 for GEM libraries.

```
MBR=( from-name, to-name)
      ( , to-name)
      ( from-name)
      from-name
```

MEMBER (M)

Selects a specific member in a PDS. The member name can be up to eight characters long. Separate multiple member names with a comma and surround the names with parentheses.

```
M={ member-name
    { (member-name1, member-name2... ) }
```

MEMBERS (MS)

Selects a group of members from a PDS. The mask name can be up to eight characters. Use a - (hyphen), % percent sign, * (asterisk), or ? (question mark) to specify wildcard characters.

```
MS={ ALL }
    { mask-name }
```

MOVE (MV)

Builds an output record by moving data to it from either the input record or control cards. The output area is initialized to the PADCHAR value (default of X'00'). You must build the entire output record. Syntax 1 moves input record data to an output record. Syntax 2 moves data contained in a control card to an output record.

Input Record Data:

```
MV=( to-location, length, from-location )
```

Control Card Data:

```
MV=( to-location, [dupl] data )
```

NEWMEM (NM)

Assigns a new name to a member of an output PDS during a COPY function. The member name can be up to eight characters.

```
NM=member-name
```

NEWMEMS (NMS)

Assigns new names to multiple members of an output PDS during a COPY function. Use a hyphen (-) to specify the characters to retain from the original member name.

```
NMS=mask-name
```

ORIF (OR)

See "IF (AND, ORIF)" on page 64.

ORIFNOT

See "IFNOT" on page 64.

OUT (O)

Limits the number of records written to the output dataset or SYSLIST DD statement. OUT=0 processes the entire file.

```
O=n
```

PADCHAR (PAD)

Specifies a pad value. PADCHAR is only applicable for sequential files. Initializes output areas when used with the MOVE parameter. Use C to specify character data, or X for hexadecimal data. X'00' is the default.

```
PAD={ C 'c' }
     { X 'nn' }
```

PANSTAT (STA)

Selects members based on CA Panvalet status type. This parameter is valid only for Panvalet members.

STA=x

PDSSTAT (MPS)

Maintains PDS member statistics when updating partitioned datasets. It maintains only standard directory entries. Valid only with the UPDATE function.

MPS=x

Values for x are:

- Y** Update PDS statistics if they exist.
- N** Do not update PDS statistics.
- A** Update statistics, if they exist, or add statistics if they do not exist.

PRESERVE

Maintains trailing blanks (spaces) in variable length records. Valid only for COPY and USER.

PRESERVE={ **ON** }
{ OFF }

PRINT (P)

Prints n records of alphanumeric data with record number and record length displayed. PRINT=0 prints all selected records.

P=n

PRTRECS

Specifies whether to include changed, inserted, deleted, and matched records in the Compare Detail Report.

PRTRECS=(C, I, D, M)

RBA

Specifies a starting block address for BDAM, a starting byte address for VSAM ESDS or KSDS, or a relative record address for VSAM RRDS.

RBA={ n }
{ X'nn' }

RDW

Controls the inclusion or exclusion of the record descriptor word for variable-length record processing. Must be the first parameter specified after a function.

RDW=n

Values for n are:

- 0** (Default) Include the RDW during record processing and display it on output.
- 1** Include the RDW during record processing, but do not display it on output.
- 2** Do not include the RDW during record processing, but display it on output.
- 3** Do not include the RDW during record processing, and do not display it on output.

READNEXT (RN)

Ends processing of the current record and starts over with the next record. READNEXT must be coded both subordinate to and immediately followed by an IF, ORIF, or ELSE parameter.

RN

REFOUT (RFO)

Specifies which records to copy when executing a reformat definition. This parameter is used with the REFORMAT function. REFOUT=SEL copies only those records that are being reformatted.

RFO={SEL}
{ALL}

REPL (R)

Replaces the first occurrence of data. Syntax 1 replaces by location. Syntax 2 replaces based on a condition at a location. Syntax 3 replaces at an alternate location based on a condition.

1. Replace by Location:

R=(location,[dupl]new-data)

2. Replace by Condition:

R=(location,{length },[dupl]compare-data,[dupl]new-data)
{operator}

3. Replace at Alternate Location Depending on a Condition:

R=(location,{length },[dupl]compare-data,replace-location,
{operator}
[dupl]new-data)

REPLALL (RA)

Replaces all occurrences of data within the area specified by start location and length. Syntax 1 replaces by condition. Syntax 2 replaces at an alternate location depending on a condition.

1. Replace by Condition:

RA=(location,length,compare-data,[dupl]new-data)

2. Replace at Alternate Location Depending on a Condition:

RA=(location,length,compare-data,replace-location,
[dupl]new-data)

RLM

(Replace Like Members) Controls the copying of identically-named members from one PDS to another.

RLM={YES}
{NO }

RLPRINT (RLP)

Prints the associated record layouts when printing XREFs using the XRPRINT function. The dataset containing the record layouts must be specified in the DDxxRL DD statement.

```
RLP=Y
```

RMODE

Specifies the residency mode to select. Valid only with the LMODMAPA, LMODDIR, and LMODMAPN functions.

```
RMODE={ 24 }
        { ANY }
```

RRN

Specifies the relative record number for VSAM RRDS and BDAM. When the specified value exceeds the size of the dataset, the function ends. Specify n as a decimal value.

```
RRN=n
```

SELECT (S)

Selects every nth occurrence of a record for processing.

```
S=n
```

SHOW (SH)

Specifies the type of field information reported for formatted print (FPRINT) output or changes the column header information for vertical formatted print (VPRINT) output.

```
SH={ FORMAT }
    { NUMBER }
    { OFFSET }
    { PICTURE }
```

STOP (ST)

Stops processing of a function when specified criteria are met. The next function then begins processing at that record.

```
T=(location{ ,length },[dup1]data,[loc2{ ,len2 },[dup2]data2)...
   { operator}                               { oper2}
```

TYPE (TYP)

Specifies the type of conversion to invoke. Valid only with the CONVERT function.

```
TYP={ MAPSEL }
     { SELCRIT }
     { XREF }
     { IMSXREF }
```

TYPRUN

Specifies to validate the compare criteria without comparing the data. Valid only with the Compare function.

```
TYPRUN=SCAN
```

UNIT

Specifies generic unit names for the VTOCDSN, VTOCINFO, and VTOCMAP functions. The parameter must specify a unique unit. Separate multiple generic units with a comma. Up to 48 characters can be specified per unit name. The parameter is required if the VOLSER parameter is not specified for the VTOCDSN, VTOCINFO, or VTOCMAP functions. Combine UNIT with VOLSER and VOLSTAT parameters for multi-volume processing.

```
UNIT=(unit-name)
```

USERID (USR)

Selects a group of members from a PDS based on a range of user IDs.

```
USR=(from-value,to-value)
    (,to-value)
    (from-value)
    from-value
```

VOLSER (VOL)

Specifies volume serial numbers for the VTOCDSN, VTOCINFO, and VTOCMAP functions. Can contain a unique six-character name or a mask value (*). Separate multiple volume serial numbers with a comma. Up to 48 characters can be specified. Combine VOLSER with UNIT and VOLSTAT parameters for multi-volume processing. VOLSER is required if UNIT is not specified for the VTOCDSN, VTOCINFO, and VTOCMAP functions.

```
VOL=(volume-serial-number)
```

VOLSTAT (VST)

Specifies the volume status for the VTOCDSN, VTOCINFO, and VTOCMAP functions. The parameter is optional; if it is not specified, all three volume statuses are assumed.

```
VST={ PUB }
     { PRV }
     { STG }
```

VPRINT (VP)

Prints n records of vertical formatted alphanumeric data based on a supplied (DDxxRL) COBOL or PL/I layout. The LAYOUT or MAP parameter is required. The FIELDS and SHOW parameters are optional.

```
VP=n
```

WRITE (W)

Sends a record to an output file during a USER function. Datasets are defined on a corresponding JCL DD statement called "anyname".

```
W={ anyname }
  {( anyname1, anyname2... )}
```

ZERO

The ZERO parameter specifies whether numeric fields will be printed with leading zeros or not. This parameter is valid only for the FPRINT, VPRINT, and XMLGEN functions.

```
ZERO=[ON/OFF]
```

Parameter Elements

Location (*loc*)

Actual location or relative location address.

Operator (*oper*)

Binary (with binary data):

EQ	Bits are all ones
NE	Bits are all zeros
NO	Bits are not all ones
MX	Bits are mixed (ones and zeros).

Non-binary:

EQ	Equal to
NE	Not equal to
GT	Greater than
GE	Greater than or equal to
LE	Less than or equal to
LT	Less than.
BT	Between
NB	Not between

Length (*len*)

A number from 0 to 255 that does not exceed the record size. 0 searches until the end of the record.

Data

The actual data must follow one of the following data identifiers and be enclosed by single or double quotes:

C'10A11'	Character, alphanumeric
CL12'ABCD123'	Character, alphanumeric data length
X'10CF00'	Hexadecimal
P'001'	Packed
PL10'+1'	Packed data length
T'ABC'	Text
TL2'ABC'	Text, alphanumeric data length
B'01001000'	Binary mask (used for selection)
B'01001000'	Binary OR (REPL new-data only)
BM'C8'	Binary Minus (REPL parameter only new-data)
BS'01001000'	Binary Signed (ACCUM parameter only)
BX'C8'	Binary Exclusive (REPL parameter only new-data)
I'+147'	Integer (binary) data
IL2'+1'	Integer data length

To create an OR condition, separate data strings with commas. For example: **C'ABC,123'** The comma creates the OR condition, ABC or 123.

To include special characters, such as commas and quotes, as data, use double quotes. For example: **C"ABC,123"** The comma is treated as data.

Japanese DBCS Data

DBCS and single byte Katakana data is accepted as data element values. File-AID removes leading or trailing shift characters from DBCS data unless the value is enclosed in double quotes. When the KANA install option is specified for the Character Set Table in the Batch Product Option Variables, C (Character) and T (Text) identifiers are both treated as case-sensitive C (Character) data.

Operator-data-type

The following operator-data-types are valid:

EQP	Equal packed
NEP	Not equal packed
EQN	Equal numeric
NEN	Not equal numeric.

Duplication Factor (dupl)

A duplication factor shortens the notation of a data string. For example: **C'123123'** is the same as **2C'123'**.

